

## P.F.N.A Instrument Set

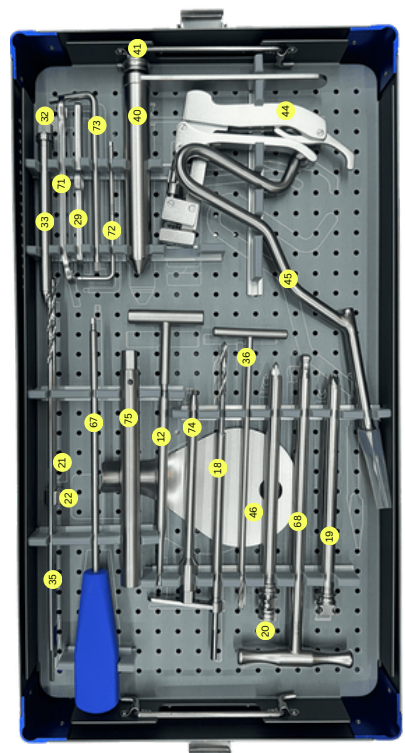

Sr.No	Product Code	Size
1	IS007-01	Insertion Handle
2	IS007-02	Conical Bolt
3	IS007-03	Proximal Aiming Bar
4	IS007-04	Proximal Bolt
5	IS007-05	Proximal Aiming Arm 130° for Blade
6	IS007-06	Aiming Arm For Dynamic/Static Locking (170/200)
7	IS007-07	Aiming Arm For Dynamic/Static Locking (220/240)
8	IS007-08	Aiming Arm For Static Locking
9	IS007-09	Bolt For Aiming Arm
10	IS007-10	Distal Aiming Bar
11	IS007-11	E Block
12	IS007-12	Position Rod
13	IS007-13	Oval Block With The Round Hole
14	IS007-14	Oval Block Locking Screw
15	IS007-15	Distal Bolt
16	IS007-16	Distal Targeter
17	IS007-17	Targeter Bolt
18	IS007-18	Protection Sleeve 11x8mm
19	IS007-19	Drill Sleeve 8x4.3mm
20	IS007-20	Trocar 4.3mm
21	IS007-21	Drill Bit 4.3x300mm
22	IS007-22	Stopper For Drill Bit 4.3mm
23	IS007-23	Depth Gauge For Blade
24	IS007-24	Protection Sleeve For Blade 16X11mm
25	IS007-25	Drill Sleeve For Blade 11X3.2mm
26	IS007-26	Trocar For Blade 3.2mm
27	IS007-27	Hammer Guide For Blade
28	IS007-28	Impactor For Blade 4.5mm Tip
29	IS007-29	Key For Blade
30	IS007-30	Extractor For Blade
31	IS007-31	Buttress/Compression Nut
32	IS007-32	Protection Sleeve 10X8mm
33	IS007-33	Trocar 8mm
34	IS007-34	Drill Sleeve 8X5.2mm
35	IS007-35	Drill Bit 5.2x250mm
36	IS007-36	T-Type Drill Bit 5.2mm
37	IS007-37	Cannulated Reamer 11mm
38	IS007-38	Entry Reamer 11mm For Blade

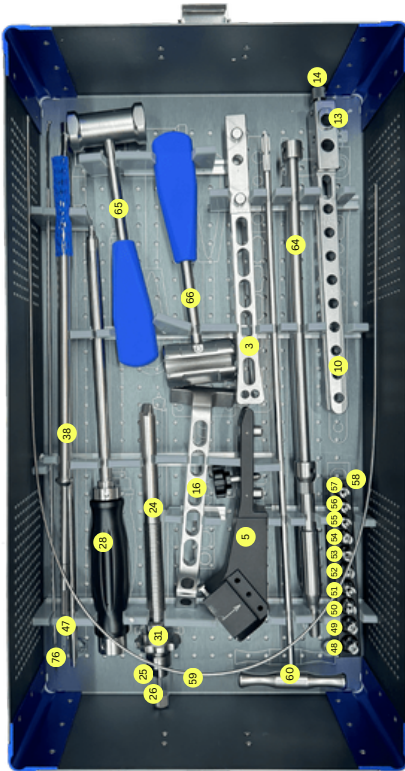
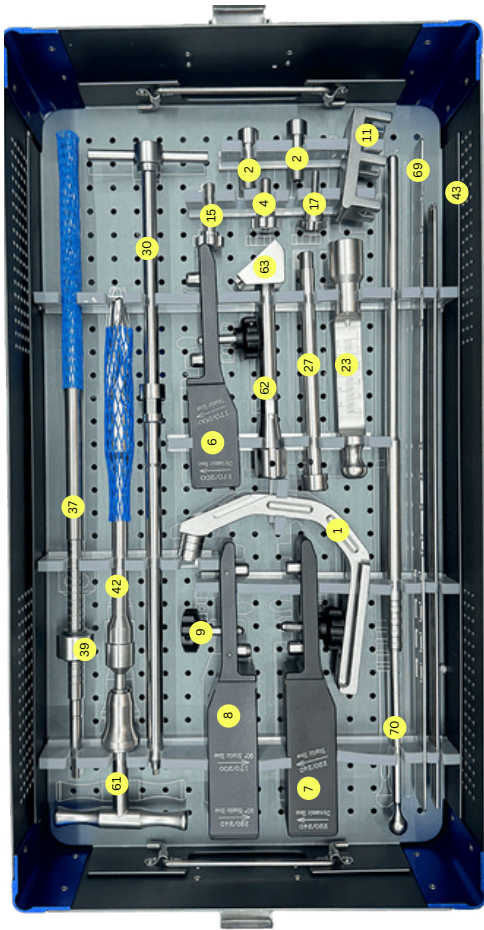

Sr.No	Product Code	Size
39	IS007-39	Stopper for Cannulated Reamer
40	IS007-40	Protection Sleeve 21X17mm
41	IS007-41	Guide Sleeve 17x3.2mm
42	IS007-42	Entry Reamer 17mm
43	IS007-43	Guide Wire Threaded 3.2x400mm
44	IS007-44	Guide Wire Holder
45	IS007-45	Bone Awl Cannulated
46	IS007-46	Tissue Protector
47	IS007-47	Flexible Reamer Shaft
48	IS007-48	Reamer Head 9.0mm
49	IS007-49	Reamer Head 9.5mm
50	IS007-50	Reamer Head 10.0mm
51	IS007-51	Reamer Head 10.5mm
52	IS007-52	Reamer Head 11.0mm
53	IS007-53	Reamer Head 11.5mm
54	IS007-54	Reamer Head 12.0mm
55	IS007-55	Reamer Head 12.5mm
56	IS007-56	Reamer Head 13.0mm
57	IS007-57	Reamer Head 13.5mm
58	IS007-58	Reamer Head Box
59	IS007-59	Guide Wire Beaded 2.5x1000mm
60	IS007-60	Guide Wire Reducer
61	IS007-61	Quick Coupling T-Handle
62	IS007-62	Insertion Connecting rod
63	IS007-63	Insertion Connector
64	IS007-64	Impactor Extractor Rod
65	IS007-65	Hammer
66	IS007-66	Slotted Hammer
67	IS007-67	Screw Driver 3.5mm Tip
68	IS007-68	Screw Driver With Spherical Head 8mm Tip
69	IS007-69	Radiographic Scale
70	IS007-70	Depth Gauge
71	IS007-71	Combination Spanner 11mm
72	IS007-72	Allen Key 5.0mm
73	IS007-73	Allen Key 3.0mm
74	IS007-74	Screw Driver For Cannulated Cap 4mm Tip
75	IS007-75	Hexagonal Socket 11mm Cannulated
76	IS007-76	Guide Wire 3.0x460mm With Hook
77	IS007-77	Instrument Box

## DHS-DCS Instrument Set

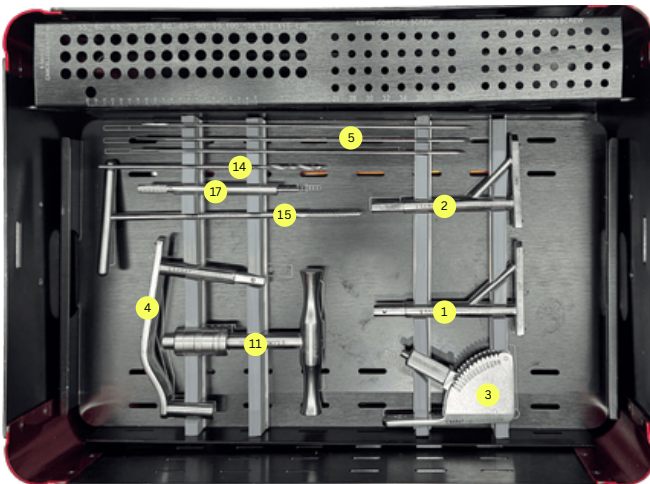
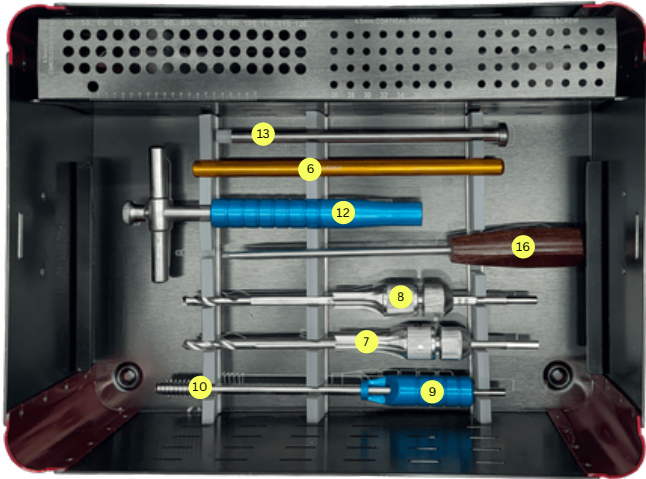

Sr.No	Product Code	Size
1	ISO19-01	DHS Angle Guide 130°
2	ISO19-02	DHS Angle Guide 135°
3	ISO19-03	DHS Angle Guide Adjustable
4	ISO19-04	DCS Angle Guide 95°
5	ISO19-05	Guide Wire Simple 2.5x225mm
6	ISO19-06	Direct Measuring Device
7	ISO19-07	DHS Triple Reamer Long Barrel
8	ISO19-08	DHS Triple Reamer Short Barrel
9	ISO19-09	Centric Sleeve for Tap
10	ISO19-10	Tap 12.5mm
11	ISO19-11	Quick Coupling T-Handle
12	ISO19-12	DHS Wrench
13	ISO19-13	DHS Impactor
14	ISO19-14	Drill Bit 3.2X150mm
15	ISO19-15	Tap 4.5mm
16	ISO19-16	Screw Driver 3.5mm Tip
17	ISO19-17	Locking Drill Sleeve 5.0-4.3mm
18	ISO19-18	Instrument Box

## Condylar Angled Blade Plate Instrument Set

Sr.No	Product Code	Size
1	ISO21-01	Chisel Guide
2	ISO21-02	Seating Chisel
3	ISO21-03	Insertor Extractor
4	ISO21-04	Slotted Hammer
5	ISO21-05	Impactor
6	ISO21-06	Spanner 11mm
7	ISO21-07	Triangular Positioning Plates (30°,70°,80°)
8	ISO21-08	Triangular Positioning Plates (40°,50°,90°)
9	ISO21-09	Quadrangular Positioning Plate (90°,110°,70°,90°)
10	ISO21-10	Triple Drill Guide 130°
11	ISO21-11	Condylar Plate Guide
12	ISO21-12	Drill Bit 2x150mm
13	ISO21-13	Drill and Tap Sleeve Combine 2.5-3.5mm
14	ISO21-14	Neutral & Loaded Drill Guide 2.5-3.5mm
15	ISO21-15	Screw Driver 3.5mm Tip
16	ISO21-16	Bone Tap 4.5mm Cortex

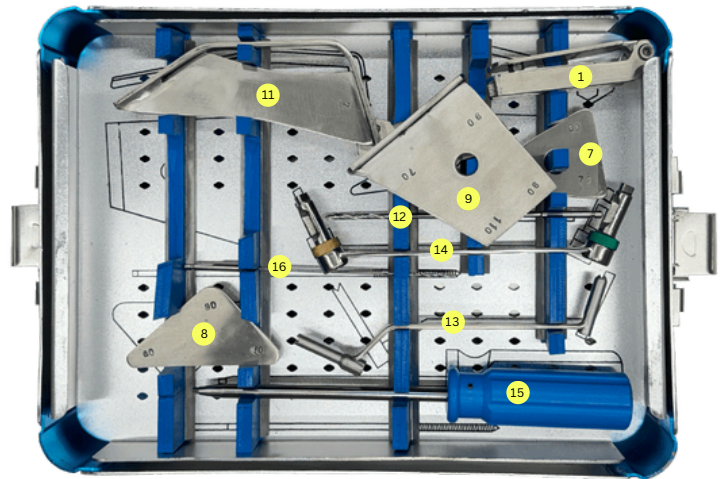
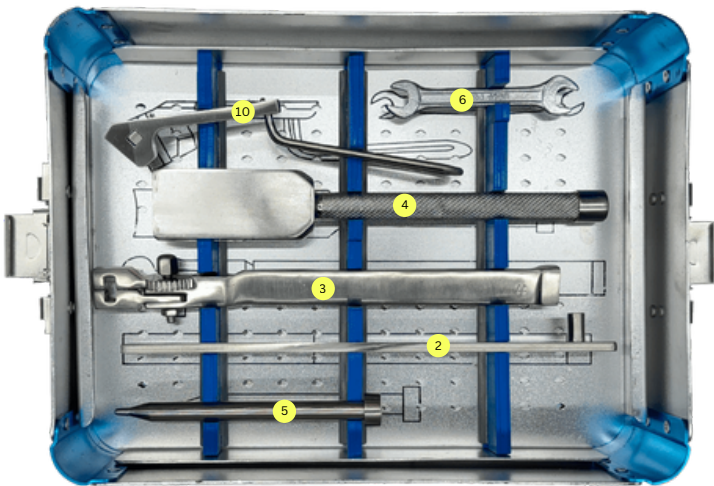

## Small Fragments Instruments Set Type II

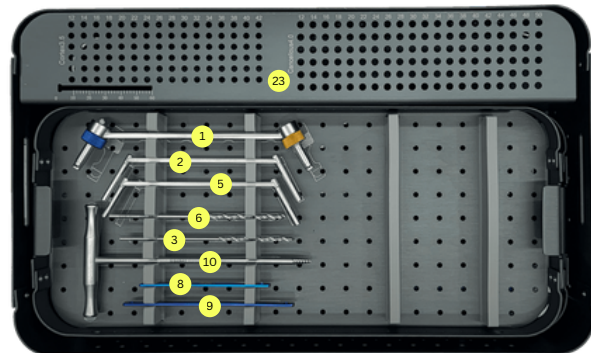
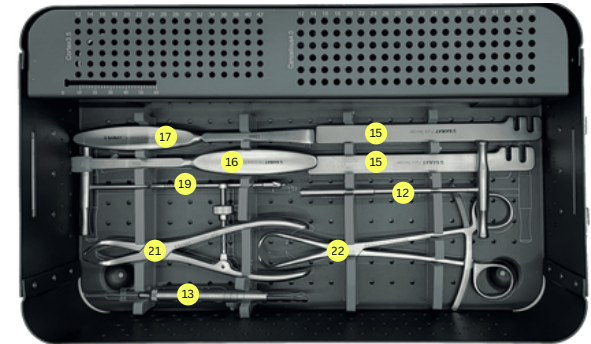
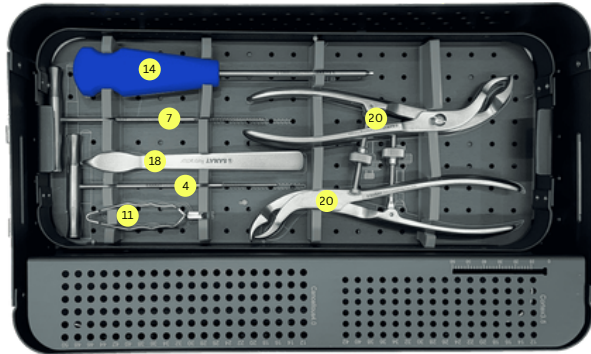

Sr.No	Product Code	Size
1	IS022-01	Neutral & Loaded Drill Guide 2.5-3.5mm
2	IS022-02	Drill and Tap Sleeve Combine 2.5-3.5mm
3	IS022-03	Drill Bit 2.5X115mm
4	IS022-04	Bone Tap 3.5mmx1.25Pitch Cortex
5	IS022-05	Drill and Tap Sleeve Combine 3.0-4.0mm
6	IS022-06	Drill Bit 3.0X115mm
7	IS022-07	Bone Tap 4.0mm Cancellous
8	IS022-08	Bending Template 10-87mm
9	IS022-09	Bending Template 10-114mm
10	IS022-10	Anti-Slip Screw Extractor 2.5mm Hex
11	IS022-11	Screw Holding Forceps
12	IS022-12	Hollow Mill 6mm Head
13	IS022-13	Depth Gauge
14	IS022-14	Screw Driver 2.5mm Tip
15	IS022-15	Small Plate Bender (Pair)
16	IS022-16	Periosteal Elevator Curved 9mm
17	IS022-17	Periosteal Elevator Curved 12mm
18	IS022-18	Hohmann Retractor 15mm
19	IS022-19	Counter Sink 6mm Head
20	IS022-20	Self Centering Bone Holding Forceps 190mm
21	IS022-21	Reduction Forceps Serrated - Speed Lock 170mm
22	IS022-22	Reduction Forceps Pointed - Ratchet Lock 200mm
23	IS022-23	Screw Tray
24	IS022-24	Instrument Box

## Large Fragments Instruments Set Type II

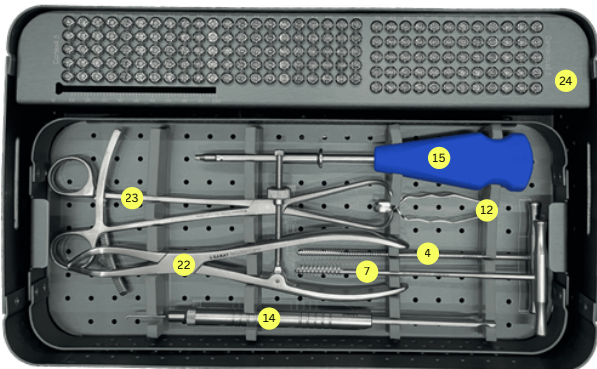
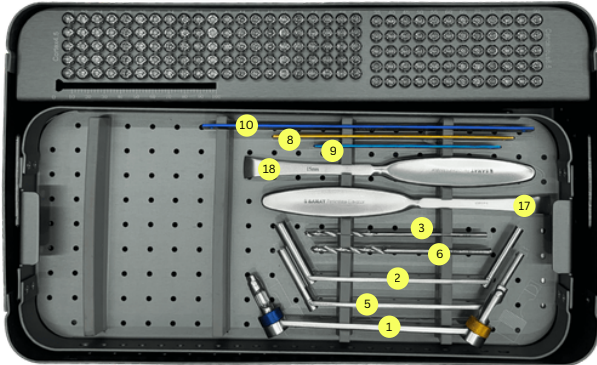
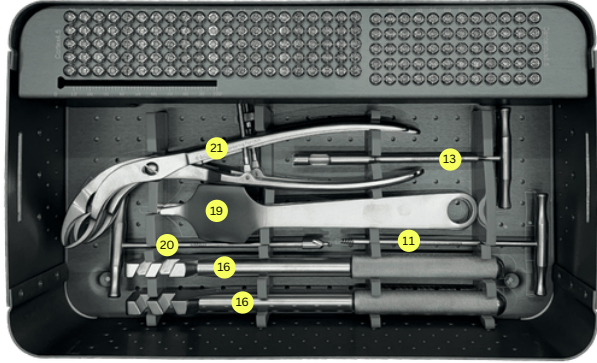

Sr.No	Product Code	Size
1	ISO23-01	Neutral & Loaded Drill Guide 3.2-4.5mm
2	ISO23-02	Drill and Tap Sleeve Combine 3.2-4.5mm
3	ISO23-03	Drill Bit 3.2X115mm
4	ISO23-04	Bone Tap 4.5mm Cortex Long
5	ISO23-05	Drill and Tap Sleeve Combine 4.5-6.5mm
6	ISO23-06	Drill Bit 4.5X115mm
7	ISO23-07	Bone Tap 6.5mm Cancellous
8	ISO23-08	Bending Template 12-120mm
9	ISO23-09	Bending Template 11-155mm
10	ISO23-10	Bending Template 12-210mm
11	ISO23-11	Anti-Slip Screw Extractor 3.5mm Hex
12	ISO23-12	Screw Holding Forceps
13	ISO23-13	Hollow Mill 8mm Head
14	ISO23-14	Depth Gauge
15	ISO23-15	Screw Driver 3.5mm Tip
16	ISO23-16	Large Plate Bender (Pair)
17	ISO23-17	Periosteal Elevator Curved 12mm
18	ISO23-18	Periosteal Elevator Curved 15mm
19	ISO23-19	Hohmann Retractor 43mm
20	ISO23-20	Counter Sink 8mm Head
21	ISO23-21	Self Centering Bone Holding Forceps 260mm
22	ISO23-22	Reduction Forceps Serrated - Speed Lock 225mm
23	ISO23-23	Reduction Forceps Pointed - Ratchet Lock 230mm
24	ISO23-24	Screw Tray
25	ISO23-25	Instrument Box

## Small Locking Instruments Set Type II

Sr.No	Product Code	Size
1	IS024-01	Neutral & Loaded Drill Guide 2.5-3.5mm
2	IS024-02	Drill Bit 2.5X115mm
3	IS024-03	Quick Coupling Screw Driver 2.5mm Tip
4	IS024-04	Depth Gauge
5	IS024-05	Quick Coupling T-Handle
6	IS024-06	Locking Drill Sleeve 3.5mm-2.8mm
7	IS024-07	Drill Bit 2.8X150mm
8	IS024-08	Locking Drill Sleeve 3.5mm-1.2mm
9	IS024-09	Bone Tap 3.5mmx1.25Pitch Cortex
10	IS024-10	Bone Tap 3.5mm Locking
11	IS024-11	Bone Tap 4.0mm Cancellous
12	IS024-12	Anti-Slip Screw Extractor 2.5mm Hex
13	IS024-13	Quick Coupling Handle
14	IS024-14	Quick Coupling Handle Torque 1.5Nm
15	IS024-15	Instrument Box

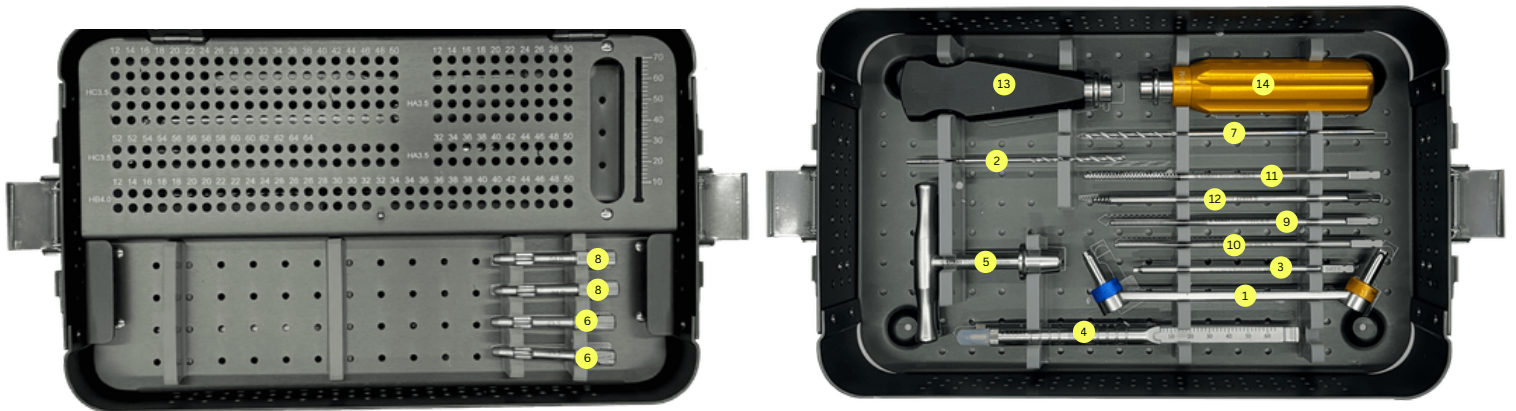

## Large Locking Instruments Set Type II

Sr.No	Product Code	Size
1	IS025-01	Neutral & Loaded Drill Guide 3.2-4.5mm
2	IS025-02	Drill Bit 3.2X150mm
3	IS025-03	Quick Coupling Screw Driver 3.5mm Tip
4	IS025-04	Depth Gauge
5	IS025-05	Quick Coupling T-Handle
6	IS025-06	Locking Drill Sleeve 5.0mm-4.3mm
7	IS025-07	Drill Bit 4.3X280mm
8	IS025-08	Locking Drill Sleeve 5.0mm-2.0mm
9	IS025-09	Bone Tap 4.5mm Cortex Long
10	IS025-10	Bone Tap 5.0mm Locking
11	IS025-11	Bone Tap 6.5mm Cancellous
12	IS025-12	Anti-Slip Screw Extractor 3.5mm Hex
13	IS025-13	Quick Coupling Handle
14	IS025-14	Quick Coupling Handle Torque 4.0Nm
15	IS025-15	Instrument Box

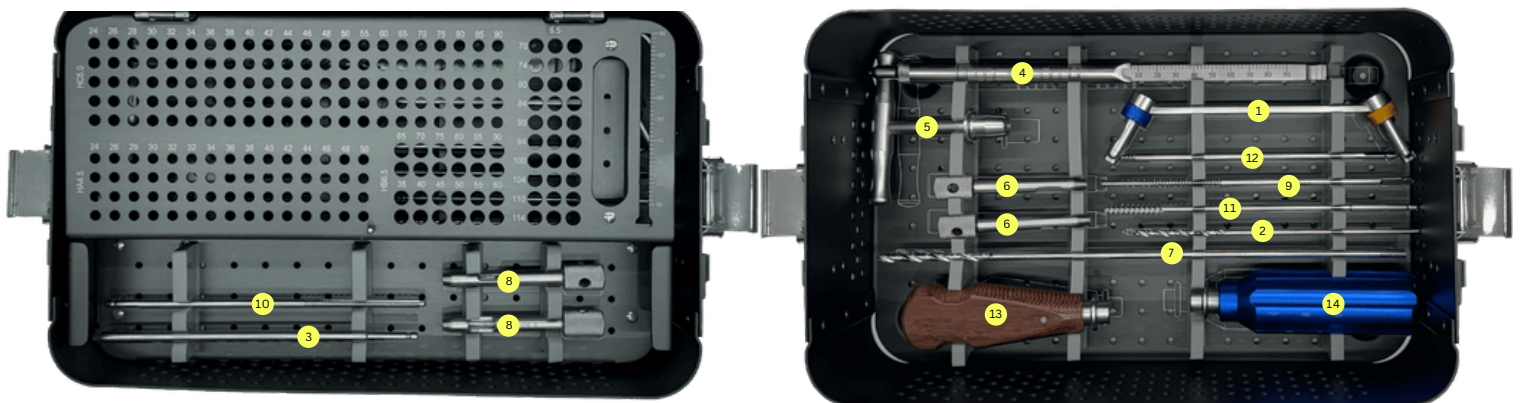

## V.A. Distal Radius Locking Plate Instrument Set

Sr.No	Product Code	Size
1	IS026-01	Guide Wire Simple 1.0x150mm
2	IS026-02	Drill and Tap Sleeve Combine 1.8-2.4mm
3	IS026-03	V.A. Drill Sleeve 1.8mm
4	IS026-04	Locking Drill Sleeve 2.7-2.0mm
5	IS026-05	Locking Drill Sleeve 2.4-1.8mm
6	IS026-06	Q.C.Drill Bit 1.8X110mm
7	IS026-07	Q.C.Drill Bit 2.0X100mm
8	IS026-08	Q.C.Screw Driver Shaft T8
9	IS026-09	Q.C.Screw Driver Shaft Short T8
10	IS026-10	Depth Gauge
11	IS026-11	Q.C. Torque Limiter 0.8Nm
12	IS026-12	Quick Coupling Handle for Torque Limiter 0.8Nm
13	IS026-13	Holding Sleeve for Screws
14	IS026-14	Instrument Box

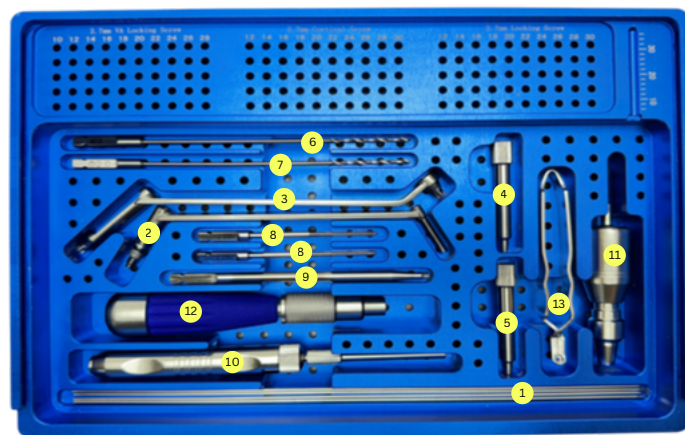

## 4.0mm Cannulated Cancellous Screw Instruments Set

Sr.No	Product Code	Size
1	IS027-01	Guide Wire Threaded 1.2x225mm
2	IS027-02	Cleaning Stylet 1.2mm
3	IS027-03	Direct Measuring Device
4	IS027-04	Cannulated Drill Bit 2.7mm
5	IS027-05	Cannulated Screw Driver 2.5mm Tip
6	IS027-06	Holding Sleeve for Screws Driver
7	IS027-07	Cannulated Counter Sink 6mm Head
8	IS027-08	Protection Sleeve 2.7mm
9	IS027-09	Cannulated Bone Tap
10	IS027-10	Screw Tray
11	IS027-11	Instrument Box

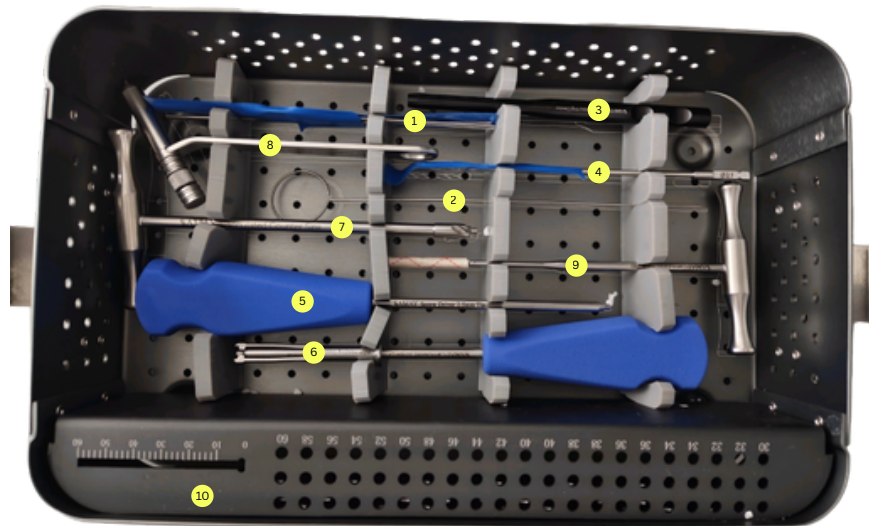

## 6.5mm and 7.0mm Cannulated Cancellous Screw Instrument Set

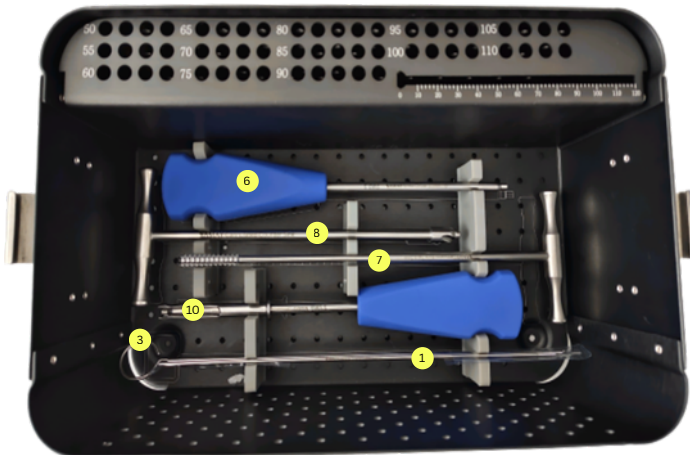
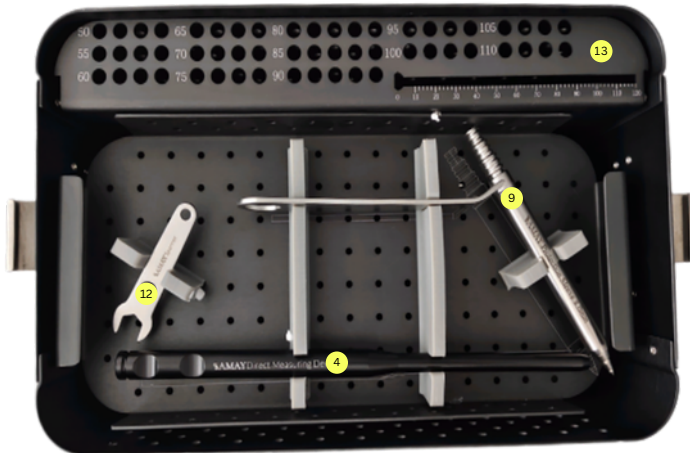
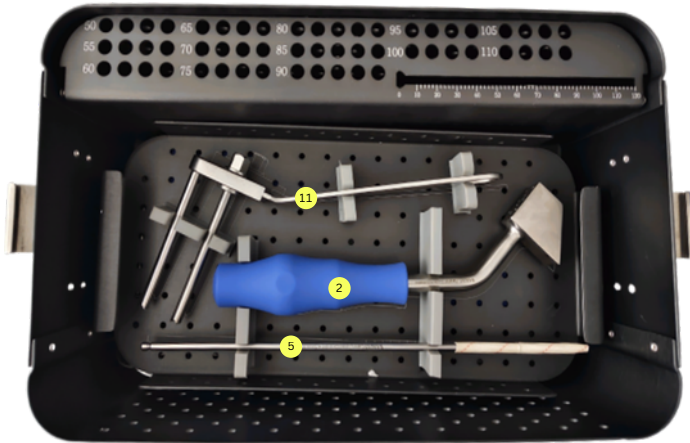

Sr.No	Product Code	Size
1	IS028-01	Guide Wire Threaded 2.0x225mm
2	IS028-02	Parallel Guide 2mm
3	IS028-03	Cleaning Stylet 2mm
4	IS028-04	Direct Measuring Device
5	IS028-05	Cannulated Drill Bit 4.5mm
6	IS028-06	Cannulated Screw Driver 3.5mm Tip
7	IS028-07	Cannulated Bone Tap For 6.5mm
8	IS028-08	Cannulated Counter Sink 8mm Head
9	IS028-09	Protection Sleeve 12x8mm
10	IS028-10	Holding Sleeve for Screws Driver
11	IS028-11	Adjustable Parallel Guide
12	IS028-12	Spanner For Adjustable Parallel Guide
13	IS028-13	Screw Tray
14	IS028-14	Instrument Box

## 7.3mm Cannulated Cancellous Screw Instrument Set

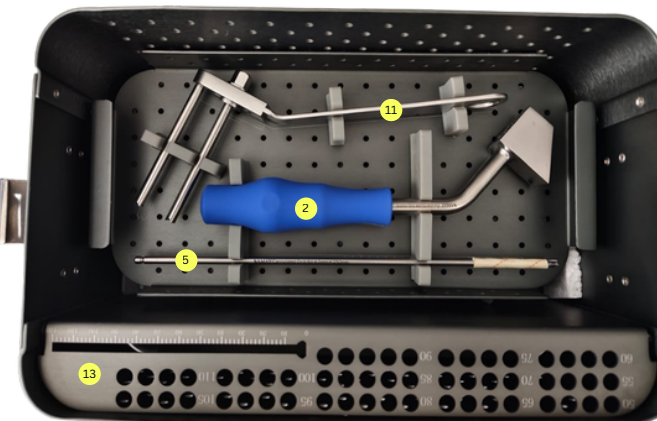
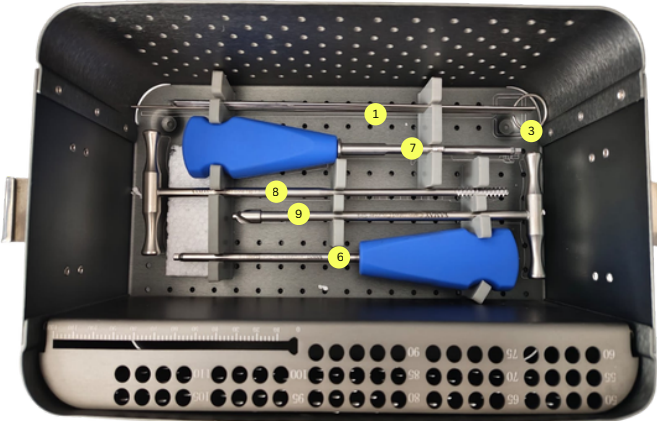
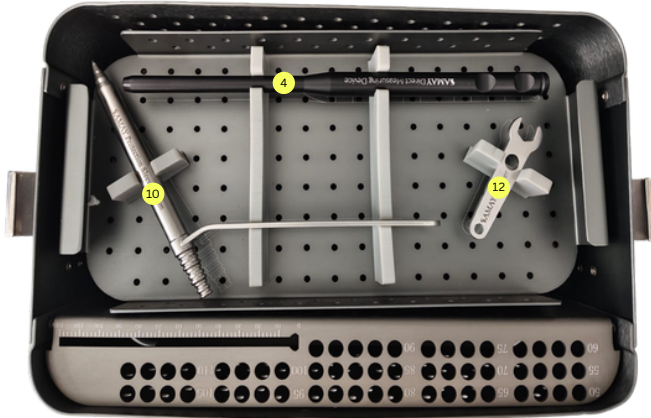

Sr.No	Product Code	Size
1	IS029-01	Guide Wire Threaded 3.0x225mm
2	IS029-02	Parallel Guide 3mm
3	IS029-03	Cleaning Stylet 3mm
4	IS029-04	Direct Measuring Device
5	IS029-05	Cannulated Drill Bit 5.0mm
6	IS029-06	Cannulated Screw Driver 3.4mm Tip
7	IS029-07	Holding Sleeve for Screws Driver
8	IS029-08	Cannulated Bone Tap For 7.3mm
9	IS029-09	Cannulated Counter Sink 8mm Head
10	IS029-10	Protection Sleeve 12x8mm
11	IS029-11	Adjustable Parallel Guide
12	IS029-12	Spanner For Adjustable Parallel Guide
13	IS029-13	Screw Tray
14	IS029-14	Instrument Box

### 3.5mm Herbert Screw Instruments Set

Sr.No	Product Code	Size
1	IS030-01	Guide Wire Simple 1.0x225mm
2	IS030-02	Cannulated Screw Driver 2.5mm Tip
3	IS030-03	Q.C Cannulated Drill Bit 2.7mm
4	IS030-04	Q.C Cannulated Bone Tap For 3.5mm
5	IS030-05	Screw Tray
6	IS030-06	Instrument Box



## 2.7mm and 2.5mm Herbert Screw Instruments Set

Sr.No	Product Code	Size
1	ISO31-01	Guide Wire Simple 1.0x225mm
2	ISO31-02	Guide Wire Threaded 1.0x225mm
3	ISO31-03	Cannulated Screw Driver 2mm Tip
4	ISO31-04	Q.C Cannulated Drill Bit 2mm
5	ISO31-05	Q.C Cannulated Counter Sink
6	ISO31-06	Screw Tray
7	ISO31-07	Instrument Box

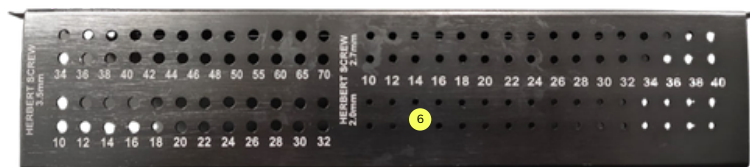
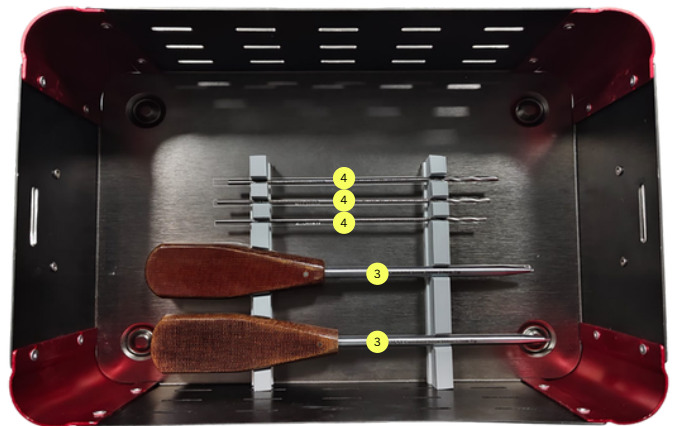
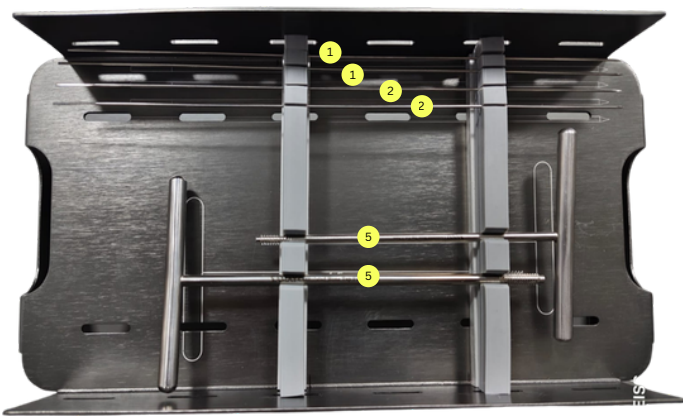

## 2.0mm Herbert Screw Instruments Set

Sr.No	Product Code	Size
1	ISO32-01	Guide Wire Simple 0.8x225mm
2	ISO32-02	Guide Wire Threaded 0.8x225mm
3	ISO32-03	Cannulated Screw Driver 1.5mm Tip
4	ISO32-04	Q.C Cannulated Drill Bit 1.8mm
5	ISO32-05	Q.C Cannulated Counter Sink
6	ISO32-06	Screw Tray
7	ISO32-07	Instrument Box

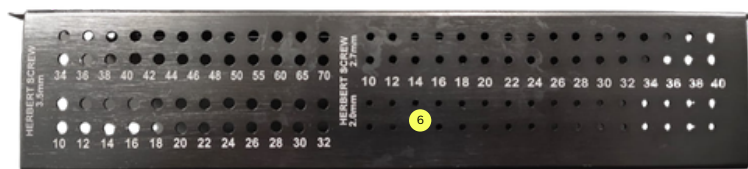
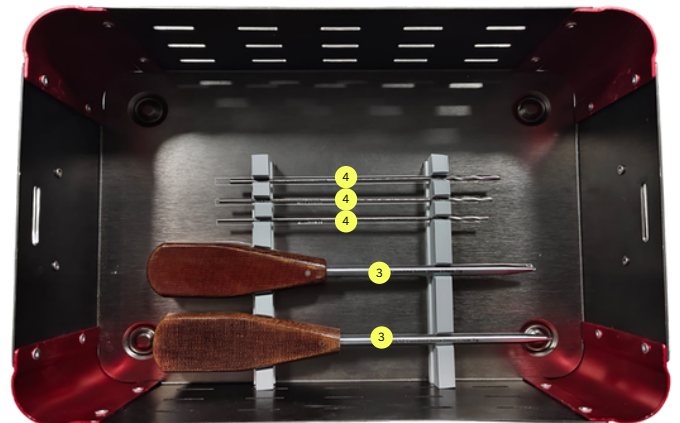
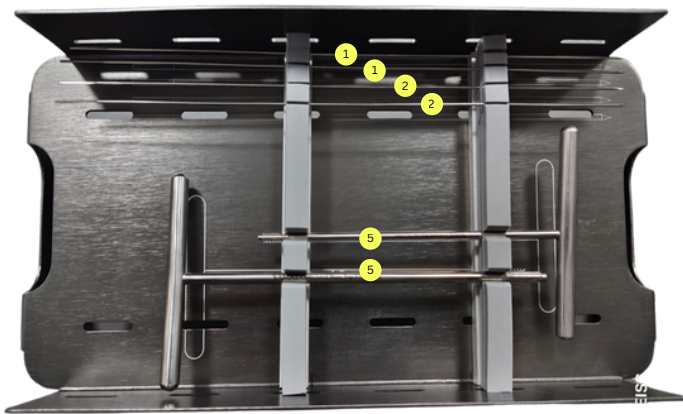

## Pelvic Instruments Set Type-I

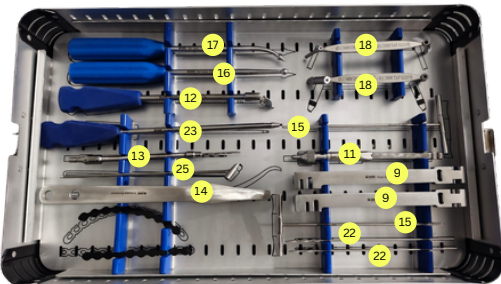
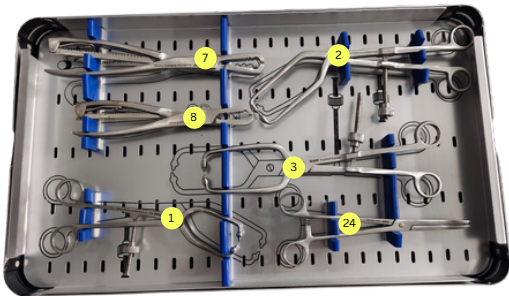
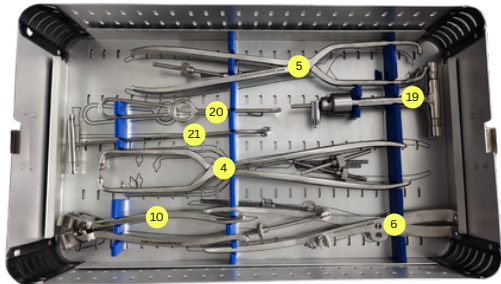

Sr.No	Product Code	Size
1	IS034-01	Pelvic Reduction Forceps Oblique 190mm
2	IS034-02	Pelvic Reduction Forceps Oblique 240mm
3	IS034-03	Pelvic Reduction Forceps Straight 240mm
4	IS034-04	Pelvic Reduction Forceps Straight 400mm
5	IS034-05	Pelvic Reduction Forceps With Three Pointed 400mm
6	IS034-06	Pelvic Reduction Forceps Asymmetric 400mm
7	IS034-07	Pelvic Reduction Forceps For Screw 330mm
8	IS034-08	Pelvic Reduction Forceps for Screw 200mm
9	IS034-09	Reconstruction Plate Bender Pair
10	IS034-10	Plate Bender for Reconstruction Plates
11	IS034-11	Depth Gauge
12	IS034-12	Flexible Screw Driver 2.5mm Tip
13	IS034-13	Flexible Drill Bit 2.5mm
14	IS034-14	Hohmann Retractor Blunt
15	IS034-15	Bone Tap 3.5mmx1.25Pitch Cortex
16	IS034-16	Ball Spike Straight
17	IS034-17	Ball Spike Curved
18	IS034-18	Drill and Tap Sleeve Combine 2.5-3.5mm
19	IS034-19	Steinman Pin Introducer With S.S Chuck and Key
20	IS034-20	Bone Hook Large
21	IS034-21	T-Type Bone Hook
22	IS034-22	Drill Bit 2.5X200mm
23	IS034-23	Screw Driver 3.5mm Tip
24	IS034-24	Screw Holding Forcep
25	IS034-25	Drill Sleeve
26	IS034-26	Instrument Box

## Pelvic Instruments Set Type-II

Sr.No	Product Code	Size
1	IS035-01	Bone Hook Large
2	IS035-02	Bone Hook Large T Handle
3	IS035-03	Pelvic Reduction Forceps With Three Pointed 400mm
4	IS035-04	Pelvic Reduction Forceps Asymmetric 400mm
5	IS035-05	Plate Bender
6	IS035-06	Pelvic Reduction Forceps for Screw 200mm
7	IS035-07	Pelvic Reduction Forceps for Screw 250mm
8	IS035-08	Pelvic Reduction Forceps For Screw 330mm
9	IS035-09	Pelvic Reduction Forceps Straight 250mm
10	IS035-10	Pelvic Reduction Forceps Oblique 250mm
11	IS035-11	Pelvic Reduction Forceps Oblique 280mm
12	IS035-12	Bending Template Straight
13	IS035-13	Bending Template Curved
14	IS035-14	Plate Bender Pair
15	IS035-15	Depth Gauge
16	IS035-16	Universal Screw Driver 2.5mm Tip
17	IS035-17	Double Drill Guide 2.5-3.5mm
18	IS035-18	Double Drill Guide 3.0-4.0mm
19	IS035-19	Screw Holding Forceps
20	IS035-20	Drill Guide 2.5mm
21	IS035-21	Hohmann Retractor
22	IS035-22	Bone Tap 3.5mmx1.25Pitch Cortex
23	IS035-23	Drill Bit 2.5X150mm
24	IS035-24	Drill Bit 3.0X150mm
25	IS035-25	Flexible Drill Bit 2.5mm
26	IS035-26	Screw Driver With Self Holding Sleeve 2.5mm
27	IS035-27	Ball Spike Straight
28	IS035-28	Instrument Box

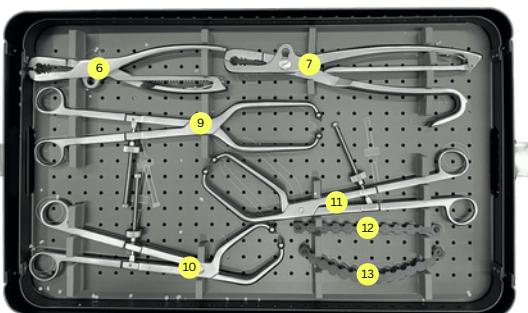
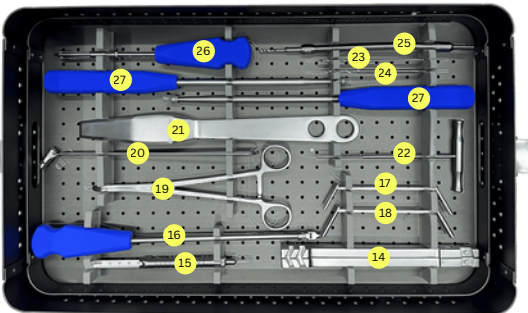
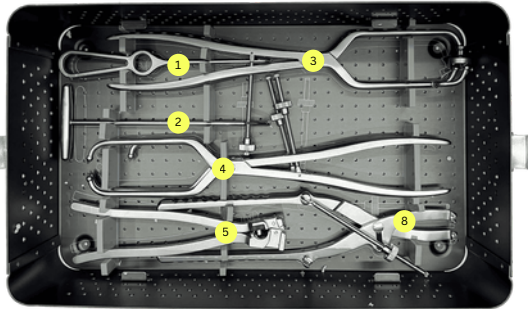

## K-Wire Instrument Set

Sr.No	Product Code	Size
1	IS036-01	Wire Tightener Cum Twister
2	IS036-02	K-Wire Bender
3	IS036-03	K-Wire Passer, Small
4	IS036-04	K-Wire Passer, Medium
5	IS036-05	K-Wire Passer, Large
6	IS036-06	Plier Cum Wire Bender Cum Wire Cutter (3 in 1) 9"
7	IS036-07	Flat Nose Plier
8	IS036-08	Steinman Pin Introducer With S.S Chuck and Key
9	IS036-09	Bone Awl With Eye
10	IS036-10	Wire Holding Forceps
11	IS036-11	K-Wire Cutter T/C Tip 225mm
12	IS036-12	Instrument Box

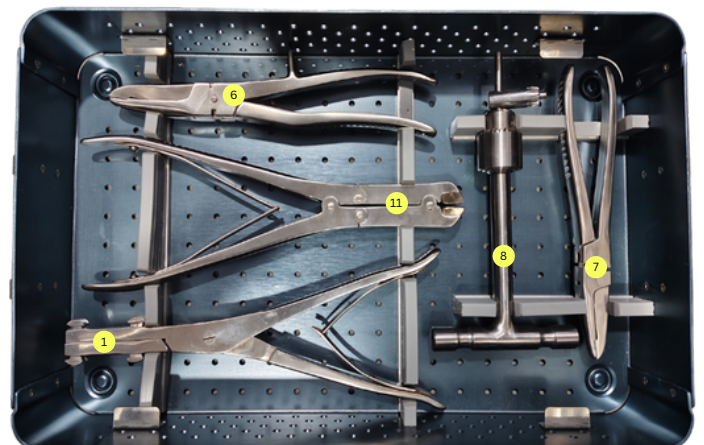
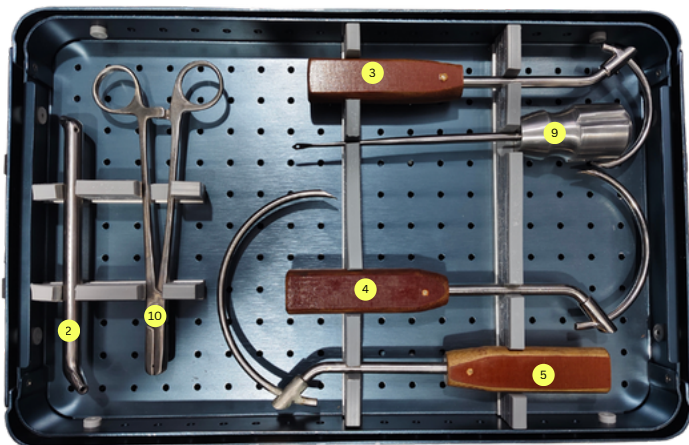

## Mini Fragments Instruments Set

Sr.No	Product Code	Size
1	IS037-01	Hexagonal Screw Driver with Sleeve 1.5mm Tip
2	IS037-02	Hexagonal Screw Driver with Sleeve 2.0mm Tip
3	IS037-03	Neutral & Loaded Drill Guide 2.0mm
4	IS037-04	Double Drill Sleeve 1.5-1.1mm
5	IS037-05	Double Drill Sleeve 2.0-1.5mm
6	IS037-06	Double Drill Sleeve 2.7-2.0mm
7	IS037-07	Plate Bender (Pair)
8	IS037-08	Triple Drill Guide 2mm
9	IS037-09	Hohmann Retractor 6mm
10	IS037-10	Hohmann Retractor 8mm
11	IS037-11	Hohmann Retractor 10mm
12	IS037-12	Gouge 4mm
13	IS037-13	Gouge 6mm
14	IS037-14	Gouge 8mm
15	IS037-15	Gouge 10mm
16	IS037-16	Osteotome 4mm
17	IS037-17	Osteotome 6mm
18	IS037-18	Osteotome 8mm
19	IS037-19	Osteotome 10mm
20	IS037-20	Chisel 4mm
21	IS037-21	Chisel 6mm
22	IS037-22	Chisel 8mm
23	IS037-23	Chisel 10mm
24	IS037-24	Sharp Hook

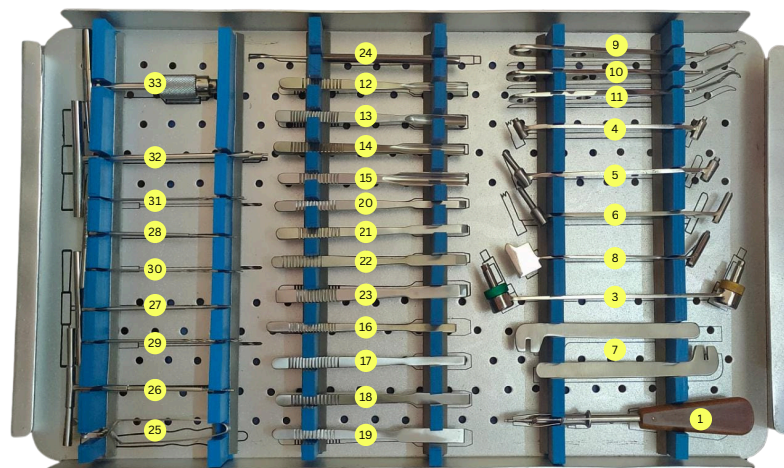

Sr.No	Product Code	Size
25	IS037-25	Screws Holding Forceps
26	IS037-26	Bone Tap 1.5mm
27	IS037-27	Bone Tap 2.0mm
28	IS037-28	Bone Tap 2.7mm
29	IS037-29	Q.C Drill Bit 1.1x100mm
30	IS037-30	Q.C Drill Bit 1.5x100mm
31	IS037-31	Q.C Drill Bit 2.0x125mm
32	IS037-32	Counter Sink
33	IS037-33	Quick Coupling T-Handle
34	IS037-34	Depth Gauge
35	IS037-35	K-Wire Bender
36	IS037-36	K-Wire Introducer
37	IS037-37	Self Retaining Retractor Alm Retractor
38	IS037-38	Hollow Mill
39	IS037-39	Periosteal Elevator
40	IS037-40	Finger Retractor
41	IS037-41	Plate & Bone Holding Forceps
42	IS037-42	Reduction Forceps Serrated
43	IS037-43	Reduction Forceps Pointed
44	IS037-44	Plier Cum Wire Bender Cum Wire Cutter (3 in 1) 7"
45	IS037-45	Fibula Forceps Straight
46	IS037-46	Self Retaining Retractor For Fingers
47	IS037-47	Self Retaining Retractor For Metacarpals
48	IS037-48	Instrument Box

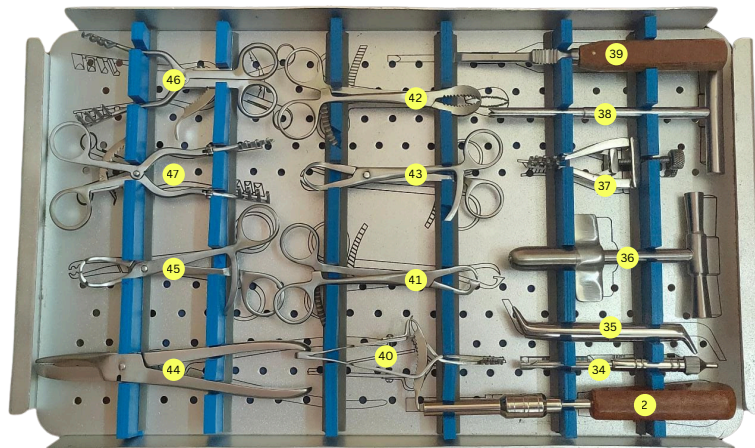

## Maxillofacial Single Slot Instruments Set

Sr.No	Product Code	Size
1	IS038-01	Screw Driver Slotted 1.5mm
2	IS038-02	Screw Driver Slotted 2.0mm
3	IS038-03	Screw Driver Slotted 2.5mm
4	IS038-04	Screw Driver With Self Holding Sleeve 1.5mm
5	IS038-05	Screw Driver With Self Holding Sleeve 2.0mm
6	IS038-06	Screw Driver With Self Holding Sleeve 2.5mm
7	IS038-07	SS Drill Bit 1x75mm
8	IS038-08	SS Drill Bit 1.5x75mm
9	IS038-09	SS Drill Bit 2x75mm
10	IS038-10	TT Drill Bit 1x75mm
11	IS038-11	TT Drill Bit 1.5x75mm
12	IS038-12	TT Drill Bit 2x75mm
13	IS038-13	Depth Gauge
14	IS038-14	Plate Bender With 3 Pins
15	IS038-15	Bending Plier
16	IS038-16	Screw Holding Forceps
17	IS038-17	Plate Cutter
18	IS038-18	Wire Cutter
19	IS038-19	Instrument Box

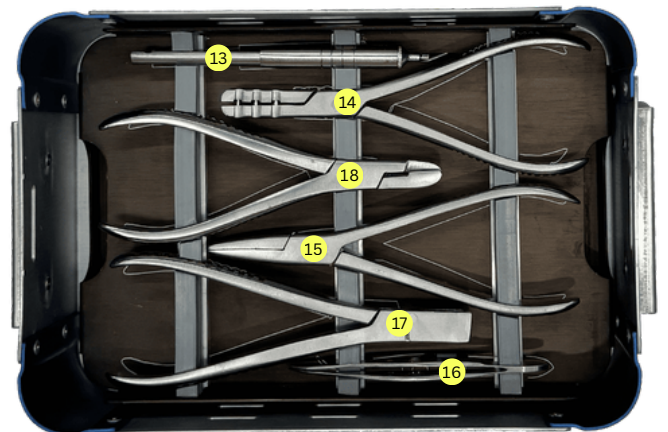
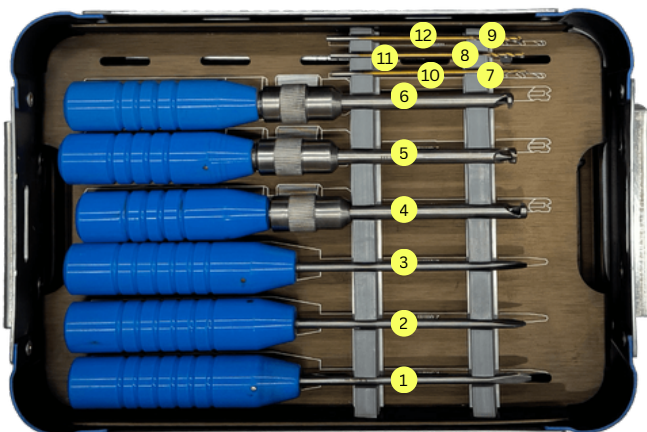

## Maxillofacial Cross Slot Instruments Set

Sr.No	Product Code	Size
1	IS039-01	Quick Coupling Handle
2	IS039-02	Q.C Screw Drive With Self Holding Sleeve 1.5mm
3	IS039-03	Q.C Screw Drive With Self Holding Sleeve 2.0mm
4	IS039-04	Q.C Screw Drive With Self Holding Sleeve 2.5mm
5	IS039-05	SS Drill Bit 1x75mm
6	IS039-06	SS Drill Bit 1.5x75mm
7	IS039-07	SS Drill Bit 2x75mm
8	IS039-08	TT Drill Bit 1x75mm
9	IS039-09	TT Drill Bit 1.5x75mm
10	IS039-10	TT Drill Bit 2x75mm
11	IS039-11	Depth Gauge
12	IS039-12	Plate Bender With 3 Pins
13	IS039-13	Bending Plier
14	IS039-14	Trocar With Sleeve
15	IS039-15	Screw Holding Forceps
16	IS039-16	Plate Cutter
17	IS039-17	Wire Cutter
18	IS039-18	Instrument Box

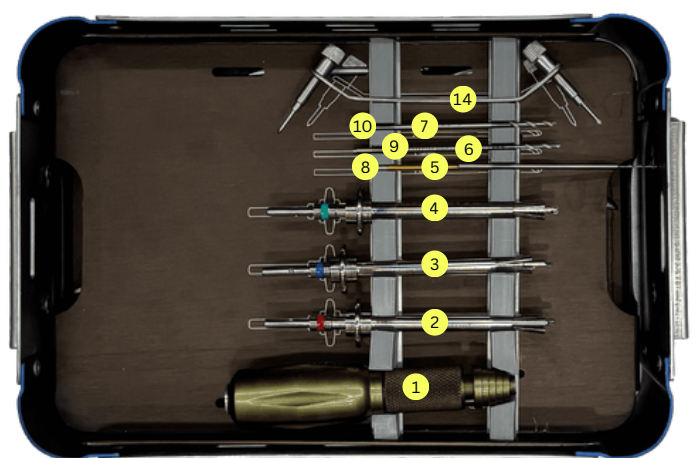
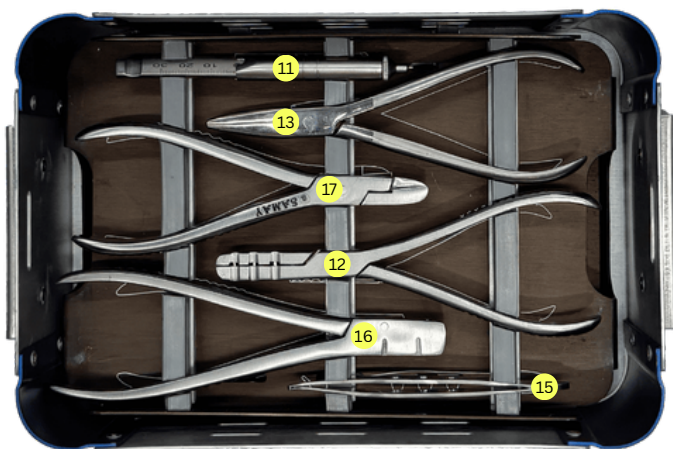

## U Staple Instruments Set

Sr.No	Product Code	Size
1	IS040-01	U-Staple Impactor/Inserter
2	IS040-02	U-Staple Starter
3	IS040-03	U-Staple Extractor
4	IS040-04	Coventry Staple Impactor
5	IS040-05	Coventry Staple Inserter



## 2.0mm Micro Plate Instrument Set

Sr.No	Product Code	Size
1	ISO46-01	Locking Drill Sleeve 2-1.5mm
2	ISO46-02	Bending Pin For 2.0mm Plate
3	ISO46-03	Drill Bit 1.5x90mm
4	ISO46-04	Screw Holding Forceps
5	ISO46-05	Sleeve For Screw Holding
6	ISO46-06	Screw Driver T6
7	ISO46-07	Double Drill Sleeve 1.5-1.1mm

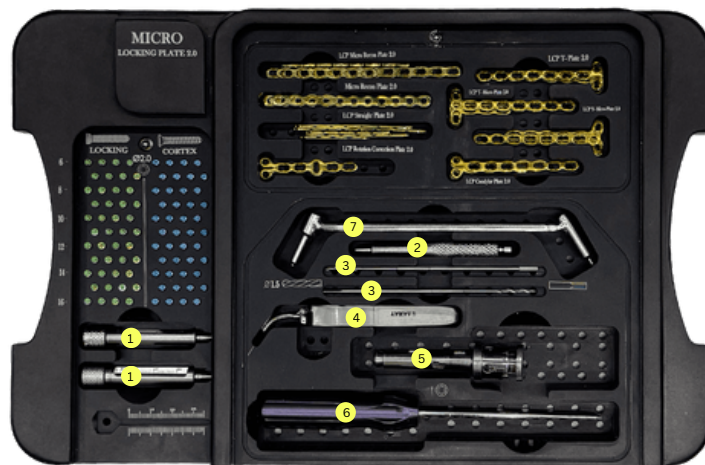

## 2.7mm Foot Instrument Set

Sr.No	Product Code	Size
1	IS047-01	Guide Wire Threaded 1.8x225mm
2	IS047-02	Double Drill Sleeve 2.7-2.0mm
3	IS047-03	Q.C Drill Bit 2.0x150mm
4	IS047-04	Q.C Bone Tap 2.7mm Screw
5	IS047-05	Q.C Screw Driver 2.0mm Tip
6	IS047-06	Screw Driver 2.0mm Tip
7	IS047-07	Quick Coupling T-Handle
8	IS047-08	Locking Drill Sleeve 2.7-2mm
9	IS047-09	K-Wire Compressor
10	IS047-10	Instrument Box

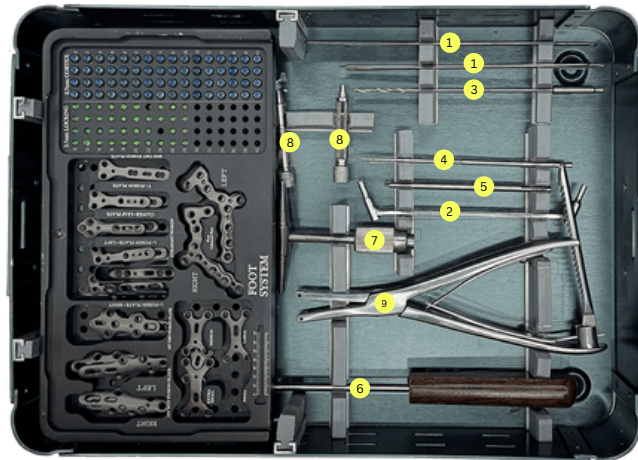

## Screw Removal Instrument Set Type-II

Sr.No	Product Code	Size
1	IS051-01	Hollow Mill 2mm
2	IS051-02	Hollow Mill 2.7mm
3	IS051-03	Hollow Mill 4mm
4	IS051-04	Hollow Mill 5mm
5	IS051-05	Hollow Mill 6.5mm
6	IS051-06	Hollow Mill 8mm
7	IS051-07	High Speed Drill Bit 4mm
8	IS051-08	High Speed Drill Bit 5mm
9	IS051-09	High Speed Drill Bit 6mm
10	IS051-10	Hexagonal Q.C Screw Driver 1mm Tip
11	IS051-11	Hexagonal Q.C Screw Driver 1.5mm Tip
12	IS051-12	Hexagonal Q.C Screw Driver 2.0mm Tip
13	IS051-13	Hexagonal Q.C Screw Driver 2.5mm Tip
14	IS051-14	Hexagonal Q.C Screw Driver 3.5mm Tip
15	IS051-15	Hexagonal Q.C Screw Driver 4.0mm Tip
16	IS051-16	Hexagonal Q.C Screw Driver 4.5mm Tip
17	IS051-17	Hexagonal Q.C Screw Driver 5.0mm Tip
18	IS051-18	Extraction Bolt 4.0mm
19	IS051-19	Extraction Bolt 5.0mm
20	IS051-20	Extraction Bolt 6.5mm
21	IS051-21	Square Screw Driver 1.2mm Tip
22	IS051-22	Square Screw Driver 1.5mm Tip
23	IS051-23	Slotted Screw Driver 0.5mm

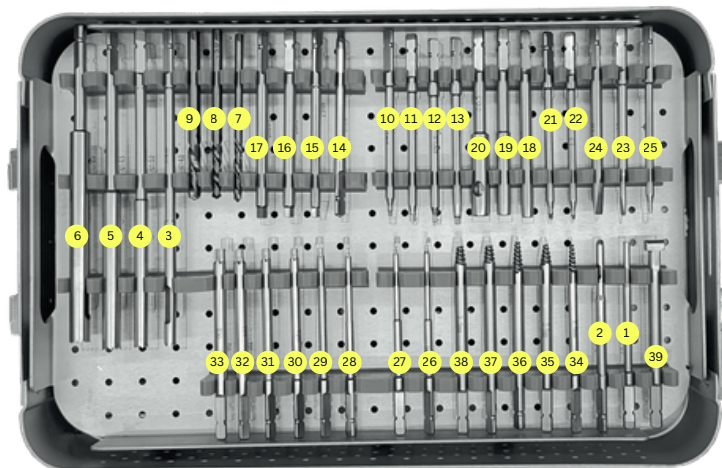

Sr.No	Product Code	Size
24	IS051-24	Slotted Screw Driver 1.0mm
25	IS051-25	Cross Screw Drive
26	IS051-26	Screw Driver Q.C T6
27	IS051-27	Screw Driver Q.C T8
28	IS051-28	Screw Driver Q.C T10
29	IS051-29	Screw Driver Q.C T15
30	IS051-30	Screw Driver Q.C T20
31	IS051-31	Screw Driver Q.C T25
32	IS051-32	Screw Driver Q.C T27
33	IS051-33	Screw Driver Q.C T30
34	IS051-34	Anti-Slip Screw Extractor 2.0mm
35	IS051-35	Anti-Slip Screw Extractor 2.5mm
36	IS051-36	Anti-Slip Screw Extractor 2.7mm
37	IS051-37	Anti-Slip Screw Extractor 3.5mm
38	IS051-38	Anti-Slip Screw Extractor 4.0mm
39	IS051-39	Spine T-Type Screw Driver
40	IS051-40	Reamer
41	IS051-41	Sharp Hook
42	IS051-42	Round Gouge
43	IS051-43	Screw Extractor
44	IS051-44	Quick Coupling T-Handle
45	IS051-45	Quick Coupling Handle
46	IS051-46	Screw Removal Plier
47	IS051-47	Instrument Box

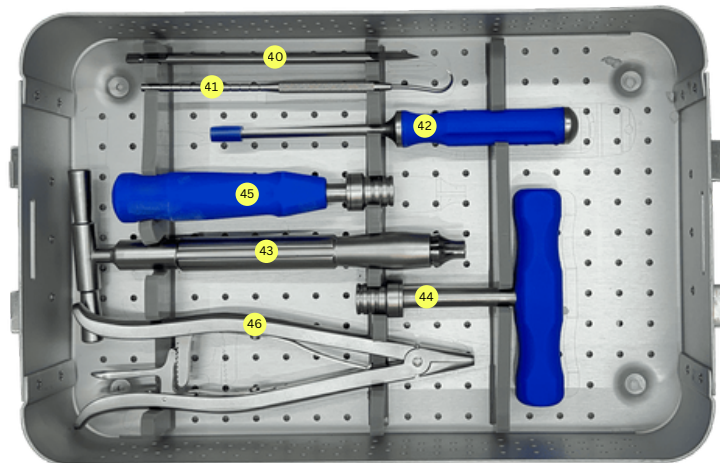

## Screw Removal Instrument Set Type-I

Sr.No	Product Code	Size
1	IS052-01	Counter Sink 5mm
2	IS052-02	Counter Sink 6mm
3	IS052-03	Counter Sink 8mm
4	IS052-04	Hollow Mill 5mm
5	IS052-05	Hollow Mill 6mm
6	IS052-06	Hollow Mill 8mm
7	IS052-07	Hollow Mill Handle
8	IS052-08	Screw Removal Plier
9	IS052-09	Sharp Hook
10	IS052-10	Hexagonal Q.C Screw Driver 2.0mm Tip
11	IS052-11	Hexagonal Q.C Screw Driver 2.5mm Tip
12	IS052-12	Hexagonal Q.C Screw Driver 3.5mm Tip
13	IS052-13	Hexagonal Cannulated Q.C Screw Driver 2.5mm Tip
14	IS052-14	Hexagonal Cannulated Q.C Screw Driver 3.5mm Tip
15	IS052-15	Anti-Slip Screw Extractor 2.5mm Hex
16	IS052-16	Anti-Slip Screw Extractor 3.5mm Hex
17	IS052-17	Screw Holding Forceps
18	IS052-18	Quick Coupling T-Handle
19	IS052-19	Quick Coupling Cannulated Handle
20	IS052-20	Round Gouge
21	IS052-21	Drill Bit 3.5x150mm
22	IS052-22	Drill Bit 4.5x150mm
23	IS052-23	Instrument Box

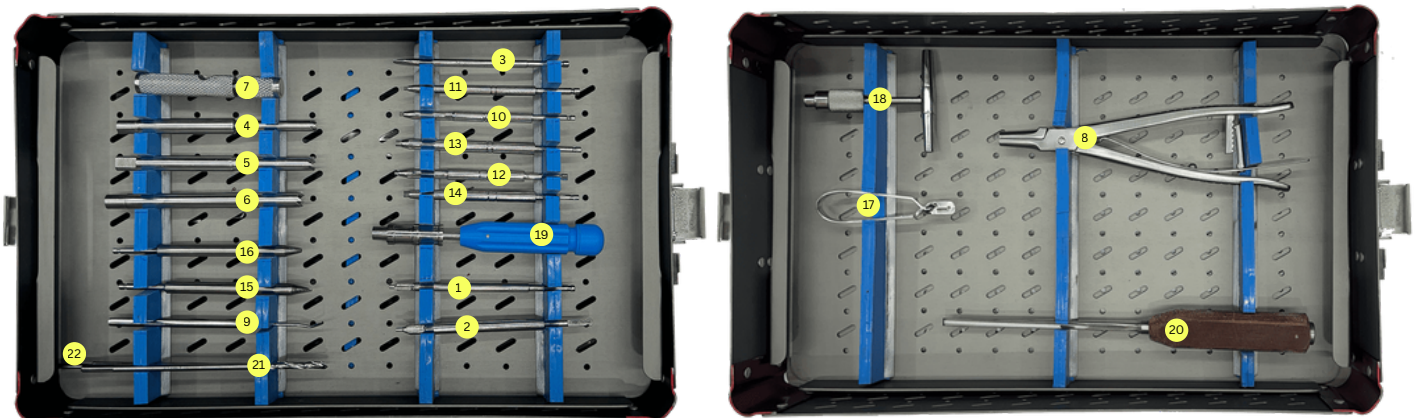

## Cable Instrument Set

Sr.No	Product Code	Size
1	IS066-01	Cable Crimper
2	IS066-02	Cable Cutter Large
3	IS066-03	Attachment Bit
4	IS066-04	Provisional Tensioning Device
5	IS066-05	Cable Cutter Standard
6	IS066-06	Medium Cable Passer
7	IS066-07	Large Cable Passer
8	IS066-08	Medium Cable Passer Curved
9	IS066-09	Large Cable Passer Curved
10	IS066-10	Cable Tensioner
11	IS066-11	Spicule Bender For Cable Plate
12	IS066-12	Impactor For Cable
13	IS066-13	Instrument Box

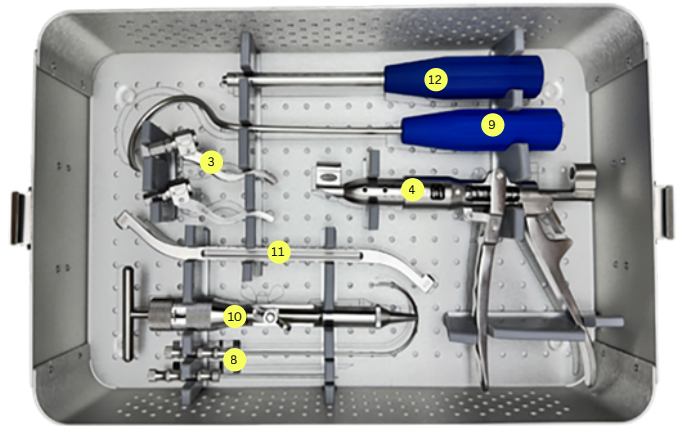
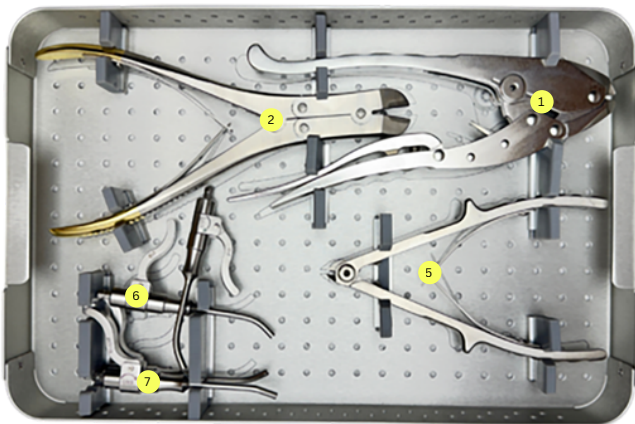

## Osteotomy Locking Plate Instrument Set

Sr.No	Product Code	Size
1	ISO67-01	Guide Wire Simple 2x280mm
2	ISO67-02	Guide Wire Simple 2.5x280mm
3	ISO67-03	Small Flute Drill Bit 2.5x300mm
4	ISO67-04	Depth Gauge
5	ISO67-05	Osteotome 10mm
6	ISO67-06	Osteotome 15mm
7	ISO67-07	Osteotome 20mm
8	ISO67-08	Osteotome 25mm
9	ISO67-09	Drill Bit 4.3X200mm
10	ISO67-10	Bone Tap for 5mm Locking Screw
11	ISO67-11	Drill Bit 3.2X200mm
12	ISO67-12	Q.C Screw Driver 3.5mm Tip
13	ISO67-13	Guide Wire Sleeve 2mm
14	ISO67-14	Measuring Ruler
15	ISO67-15	Locking Drill Sleeve Long 5.0-4.3mm
16	ISO67-16	Tap Sleeve 5mm
17	ISO67-17	Quick Coupling Handle
18	ISO67-18	Torque Handle 4.0N.m
19	ISO67-19	Bone Spreader with 8mm Blade
20	ISO67-20	Osteomy Gap Measuring Device
21	ISO67-21	Tomo Fix Bone Spreader
22	ISO67-22	Universal Drill Sleeve with 4.3mm Drill Bit
23	ISO67-23	Instrument Box

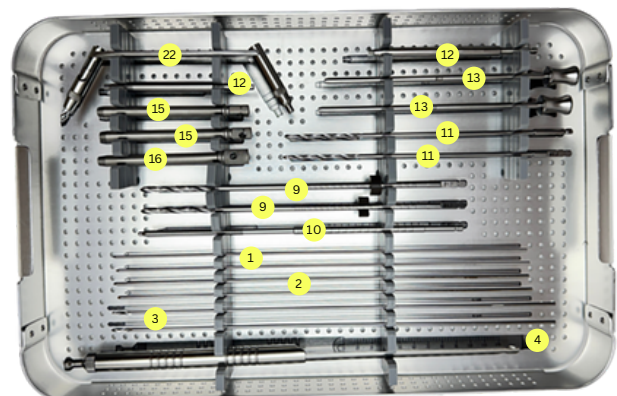
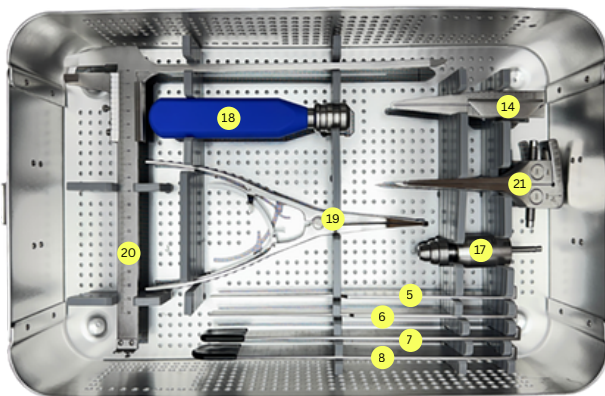

## Femoral Neck System Instrument Set

Sr.No	Product Code	Size
1	IS068-01	130° Degree Angled Guide for 3.2 mm Guide Wire
2	IS068-02	Correction Guide for 3.2 mm Guide Wire
3	IS068-03	Guide Wire Threaded 3.2mm x 400mm
4	IS068-04	Direct Measuring Device for 3.2 mm Guide Wire
5	IS068-05	Complete Opening Reamer/Drill Bit
6	IS068-06	Insertion Handle
7	IS068-07	Insert for Insertion Handle
8	IS068-08	Multifunction Rod for Insertion Instruments
9	IS068-09	Q.C. Drill Bit 4.3mm x 413mm
10	IS068-10	Stopper for Drill Bit 4.3mm
11	IS068-11	Protection Sleeve for Insertion Instruments
12	IS068-12	Q.C. Screwdriver Shaft T25
13	IS068-13	Q.C. Screwdriver Shaft 3.5mm Tip
14	IS068-14	Cylinder for Insertion Instruments
15	IS068-15	Depth Gauge
16	IS068-16	Torque Limiter 4 Nm
17	IS068-17	Quick Coupling Handle
18	IS068-18	Instrument Box

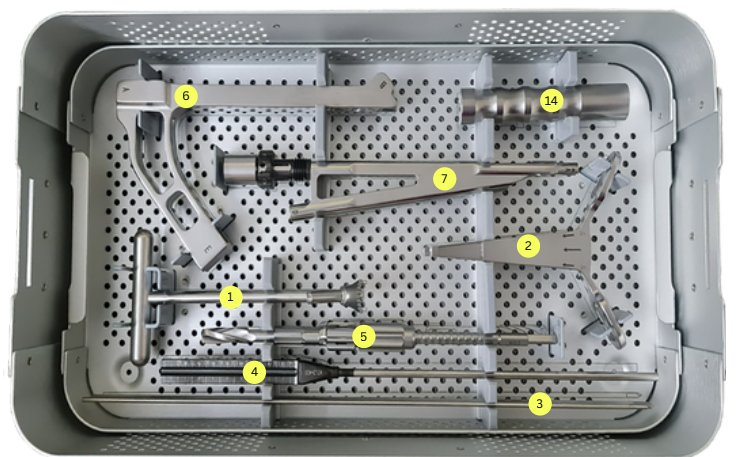
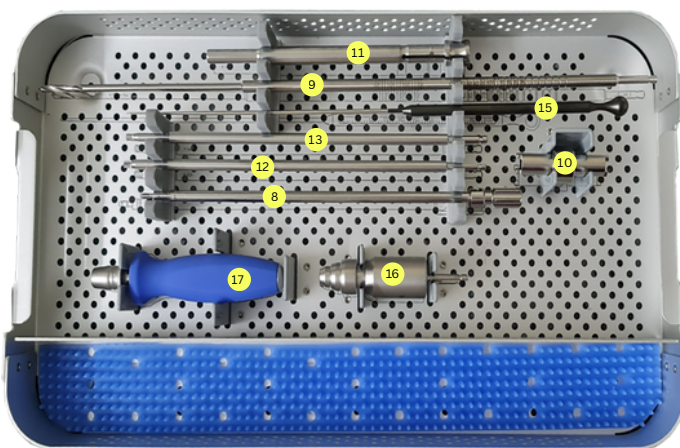

## Small Fragments Instruments Set Type I

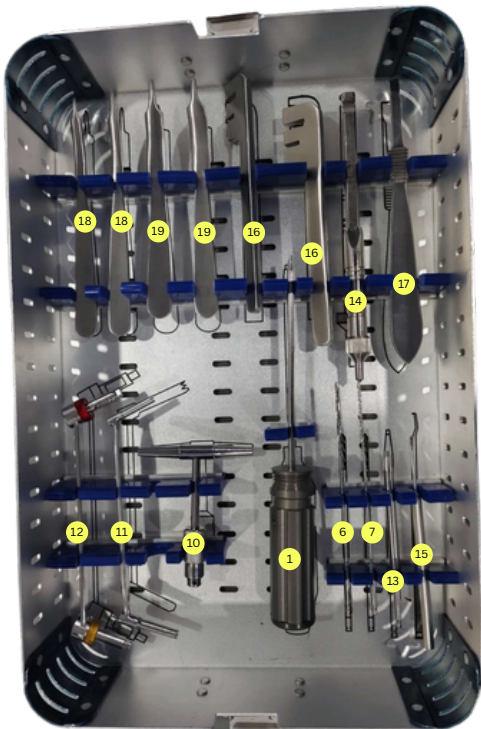

Sr.No	Product Code	Size
1	IS072-01	Screw Driver 3.5mm Tip
2	IS072-02	Counter Sink 6mm Head
3	IS072-03	Bone Tap 3.5mmx1.25Pitch Cortex
4	IS072-04	Bone Tap 4.5mm Cortex Long
5	IS072-05	Insert Drill Sleeve 3.5mm-2.5mm
6	IS072-06	Drill Bit 2.0X150mm
7	IS072-07	Drill Bit 2.5X150mm
8	IS072-08	Drill Bit 2.7X150mm
9	IS072-09	Drill Bit 3.5X150mm
10	IS072-10	Quick Coupling T-Handle
11	IS072-11	Drill and Tap Sleeve Combine 3.5-2.5mm
12	IS072-12	Neutral & Loaded Drill Guide 2.5-3.5mm
13	IS072-13	Hexagonal Quick Coupling Screw Driver
14	IS072-14	Depth Guage
15	IS072-15	Sharp Hook
16	IS072-16	Small Plate Bender (Pair)
17	IS072-17	Periosteal Elevator
18	IS072-18	Hohmann Retractor 8mm
19	IS072-19	Hohmann Retractor 12mm
20	IS072-20	Self Centering Bone Holding Forceps 190mm
21	IS072-21	Reduction Forceps Serrated - Speed Lock 170mm
22	IS072-22	Reduction Forceps Pointed - Ratchet Lock 200mm
23	IS072-23	Instrument Box

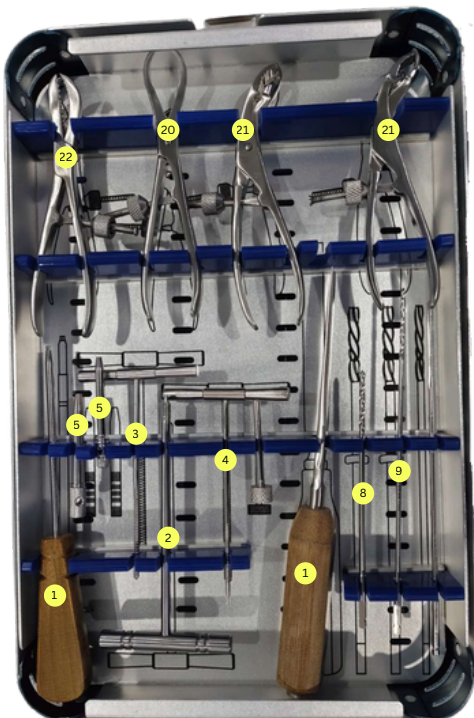

## Large Fragments Instruments Set Type I

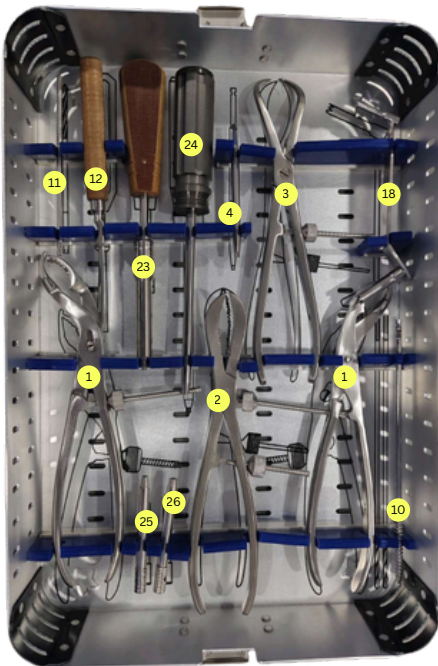
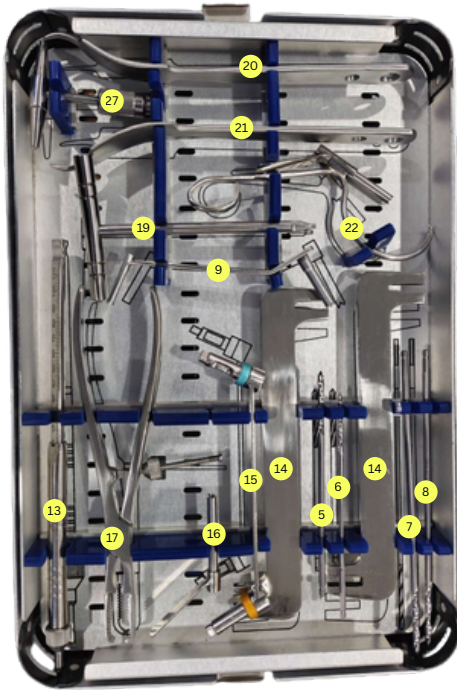

Sr.No	Product Code	Size
1	IS073-01	Self Centering Bone Holding Forceps 240mm
2	IS073-02	Reduction Forceps Serrated - Speed Lock 240mm
3	IS073-03	Reduction Forceps Pointed - Ratchet Lock 240mm
4	IS073-04	Hexagonal Quick Coupling Screw Driver
5	IS073-05	Drill Bit 3.2X150mm
6	IS073-06	Drill Bit 4.5X150mm
7	IS073-07	Drill Bit 4.3X150mm
8	IS073-08	Drill Bit 4.5X150mm
9	IS073-09	Drill and Tap Sleeve Combine 3.2-6.5mm
10	IS073-10	Bone Tap 6.5mm Cancellous
11	IS073-11	Bone Tap 4.5mm Cortex Long
12	IS073-12	Periosteal Elevator
13	IS073-13	Depth Guage
14	IS073-14	Small Plate Bender (Pair)
15	IS073-15	Neutral & Loaded Drill Guide 3.2-4.5mm
16	IS073-16	Insert Drill Sleeve 4.5-3.2mm
17	IS073-17	Bone and Plate Holding Forceps
18	IS073-18	Drill and Tap Sleeve Combine 3.2-4.5mm
19	IS073-19	Counter Sink 6mm Head
20	IS073-20	Hohmann Retractor 8mm
21	IS073-21	Hohmann Retractor 12mm
22	IS073-22	Pointed Drill Guide 4.5-3.2mm
23	IS073-23	Hexagonal Screw Driver With Self Holding Sleeve
24	IS073-24	Torque Limit Screw Driver
25	IS073-25	Locking Drill Sleeve 5.0-4.3mm
26	IS073-26	Locking Drill Sleeve 6.5-4.5mm
27	IS073-27	Quick Coupling T-Handle
28	IS073-28	Instrument Box

## Small Locking Instruments Set Type I

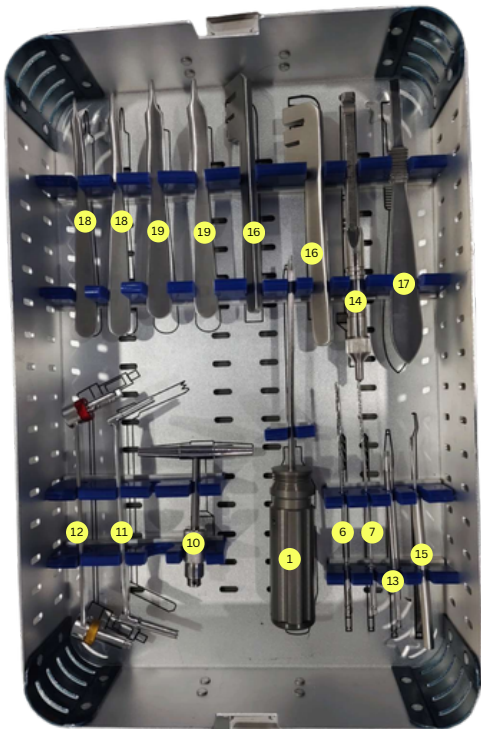

Sr.No	Product Code	Size
1	IS074-01	Screw Driver 3.5mm Tip
2	IS074-02	Counter Sink 6mm Head
3	IS074-03	Bone Tap 3.5mmx1.25Pitch Cortex
4	IS074-04	Bone Tap 4.5mm Cortex Long
5	IS074-05	Insert Drill Sleeve 3.5mm-2.5mm
6	IS074-06	Drill Bit 2.0X150mm
7	IS074-07	Drill Bit 2.5X150mm
8	IS074-08	Drill Bit 2.7X150mm
9	IS074-09	Drill Bit 3.5X150mm
10	IS074-10	Drill Bit 2.8X150mm
11	IS074-11	Quick Coupling T-Handle
12	IS074-12	Drill and Tap Sleeve Combine 3.5-2.5mm
13	IS074-13	Neutral & Loaded Drill Guide 2.5-3.5mm
14	IS074-14	Hexagonal Quick Coupling Screw Driver
15	IS074-15	Depth Gauge
16	IS074-16	Sharp Hook
17	IS074-17	Small Plate Bender (Pair)
18	IS074-18	Periosteal Elevator
19	IS074-19	Hohmann Retractor 8mm
20	IS074-20	Hohmann Retractor 12mm
21	IS074-21	Self Centering Bone Holding Forceps 190mm
22	IS074-22	Reduction Forceps Serrated - Speed Lock 170mm
23	IS074-23	Instrument Box

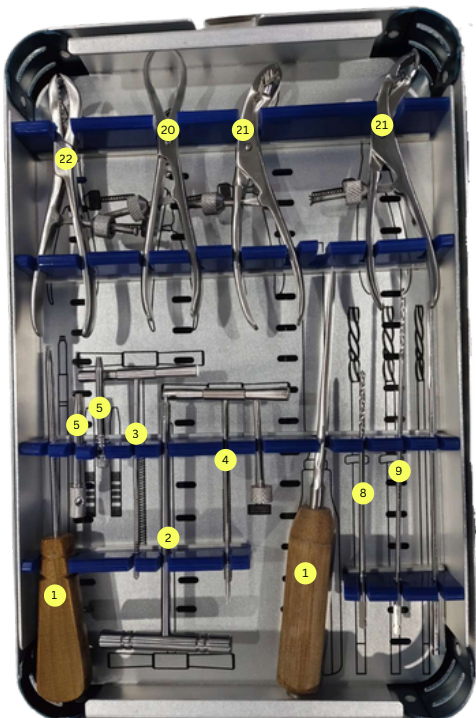

## Large Locking Instruments Set Type I

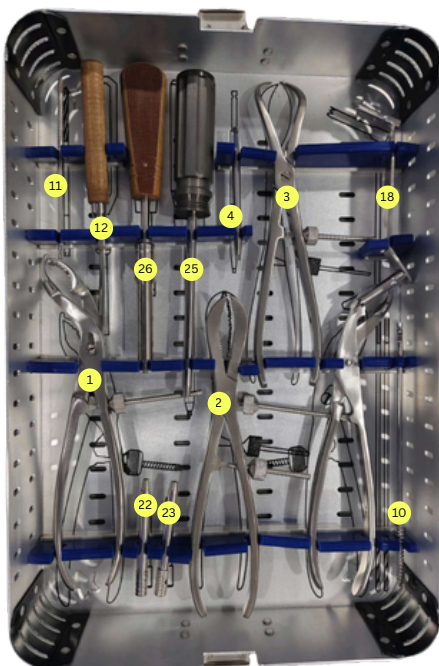
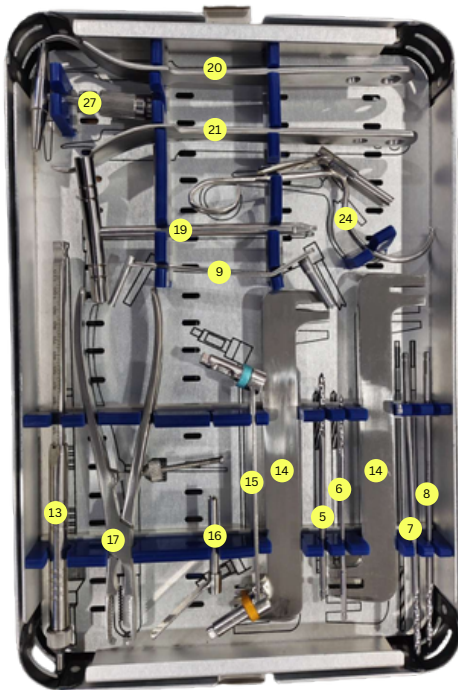

Sr.No	Product Code	Size
1	IS075-01	Self Centering Bone Holding Forceps 240mm
2	IS075-02	Reduction Forceps Serrated - Speed Lock 240mm
3	IS075-03	Reduction Forceps Pointed - Ratchet Lock 240mm
4	IS075-04	Hexagonal Quick Coupling Screw Driver
5	IS075-05	Drill Bit 3.2X150mm
6	IS075-06	Drill Bit 4.5X150mm
7	IS075-07	Drill Bit 4.3X200mm
8	IS075-08	Drill Bit 4.5X200mm
9	IS075-09	Drill and Tap Sleeve Combine 3.2-6.5mm
10	IS075-10	Bone Tap 6.5mm Cancellous
11	IS075-11	Bone Tap 4.5mm Cortex Long
12	IS075-12	Periosteal Elevator
13	IS075-13	Depth Gauge
14	IS075-14	Small Plate Bender (Pair)
15	IS075-15	Neutral & Loaded Drill Guide 3.2-4.5mm
16	IS075-16	Insert Drill Sleeve 4.5-3.2mm
17	IS075-17	Bone and Plate Holding Forceps
18	IS075-18	Drill and Tap Sleeve Combine 3.2-4.5mm
19	IS075-19	Counter Sink 6mm Head
20	IS075-20	Hohmann Retractor 8mm
21	IS075-21	Hohmann Retractor 12mm
22	IS075-22	Locking Drill Sleeve 5.0-4.3mm
23	IS075-23	Locking Drill Sleeve 6.5-4.5mm
24	IS075-24	Pointed Drill Guide 4.5-3.2mm
25	IS075-25	Torque Limit Screw Driver
26	IS075-26	Hexagonal Screw Driver With Self Holding Sleeve
27	IS075-27	Quick Coupling T-Handle
28	IS075-28	Instrument Box

## External Fixator Instrument Set

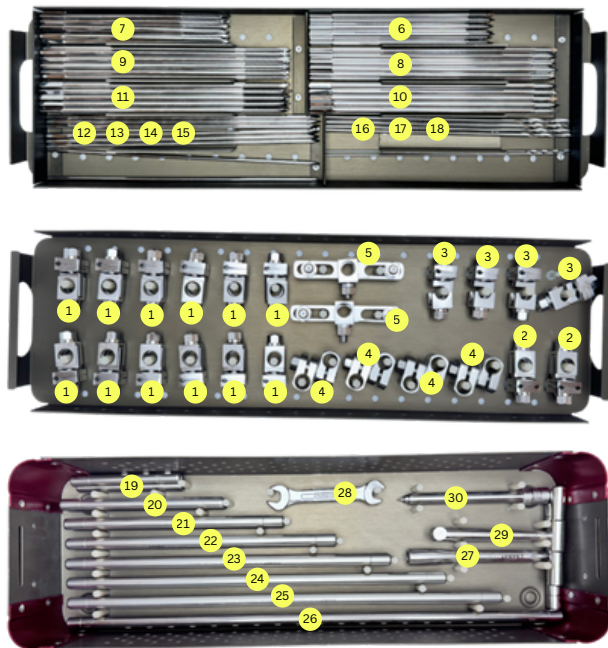

Sr.No	Product Code	Size
1	ISO41-01	A.O. Clamp Sing Pin 4.5mm X 11mm
2	ISO41-02	A.O. Clamp Double Pin 4.5mm X 11mm
3	ISO41-03	Open Clamp 4.5mm X 11mm
4	ISO41-04	Rod to Rod Clamp
5	ISO41-05	Transverse Clamp
6	ISO41-06	Schanz Screw 16th Threaded 4.5x150mm
7	ISO41-07	Schanz Screw 32th Threaded 4.5x150mm
8	ISO41-08	Schanz Screw 16th Threaded 4.5x200mm
9	ISO41-09	Schanz Screw 32th Threaded 4.5x200mm
10	ISO41-10	Schanz Screw 16th Threaded 5.0x200mm
11	ISO41-11	Schanz Screw 32th Threaded 5.0x200mm
12	ISO41-12	Steinmann Pin 3.0x225mm
13	ISO41-13	Steinmann Pin 3.5x225mm
14	ISO41-14	Steinmann Pin 4.0x225mm
15	ISO41-15	Steinmann Pin 4.5x225mm
16	ISO41-16	Drill Bit 2.0x200mm
17	ISO41-17	Drill Bit 3.2x200mm
18	ISO41-18	Drill Bit 4.0x200mm
19	ISO41-19	Connecting Rod 11x100mm
20	ISO41-20	Connecting Rod 11x150mm
21	ISO41-21	Connecting Rod 11x200mm
22	ISO41-22	Connecting Rod 11x250mm
23	ISO41-23	Connecting Rod 11x300mm
24	ISO41-24	Connecting Rod 11x350mm
25	ISO41-25	Connecting Rod 11x400mm
26	ISO41-26	Connecting Rod 11x450mm
27	ISO41-27	T-Handle Spanner 11mm
28	ISO41-28	Open Spanner 11mm
29	ISO41-29	T-Handle For Schanz Screw & Steinmann Pin
30	ISO41-30	Triple Trocar Sleeve Set
31	ISO41-31	Instrument Box

## Rail Fixator Instrument Set

Sr.No	Product Code	Size
1	ISO42-01	Rail 250mm
2	ISO42-02	Rail 300mm
3	ISO42-03	Rail 350mm
4	ISO42-04	Rail 400mm
5	ISO42-05	Rail 450mm
6	ISO42-06	Swivel Clamp
7	ISO42-07	Center Clamp
8	ISO42-08	T Clamp
9	ISO42-09	End Clamp
10	ISO42-10	CD Unit 45mm
11	ISO42-11	CD Unit 55mm
12	ISO42-12	CD Unit 80mm
13	ISO42-13	Drill Sleeve 3.5-5.0mm
14	ISO42-14	Drill Sleeve 4.5-6.0mm
15	ISO42-15	Drill Bit 3.5x200mm
16	ISO42-16	Drill Bit 4.5x200mm
17	ISO42-17	Schanz Screw Tapper Thread 32mm Threaded 5x150mm
18	ISO42-18	Schanz Screw Tapper Thread 32mm Threaded 5x200mm
19	ISO42-19	Schanz Screw Tapper Thread 32mm Threaded 6x150mm
20	ISO42-20	Schanz Screw Tapper Thread 32mm Threaded 6x200mm

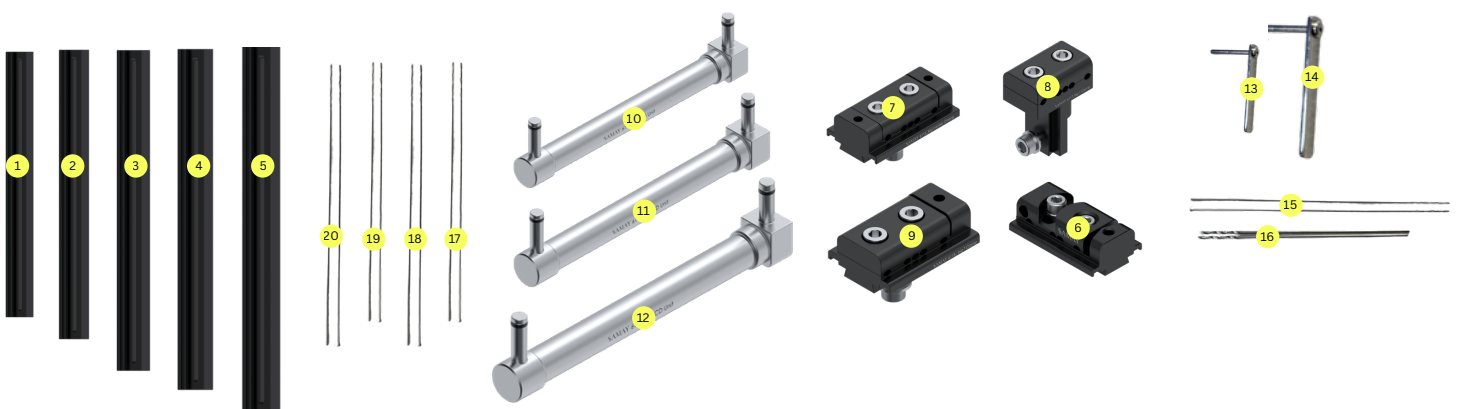

## Bipolar Instruments Set

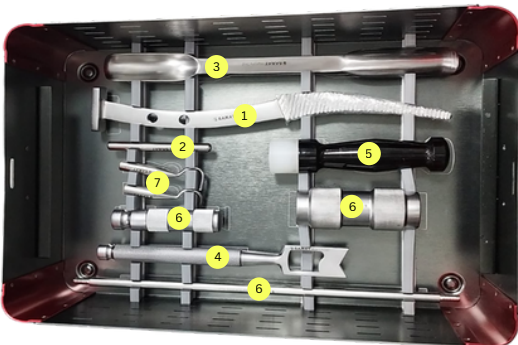
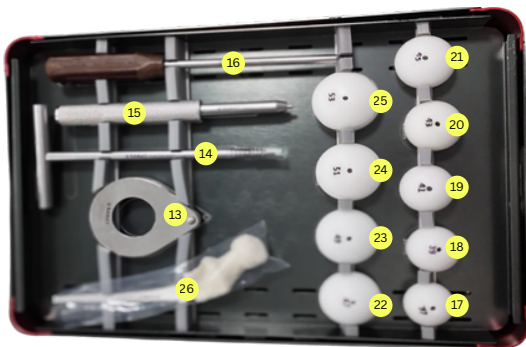
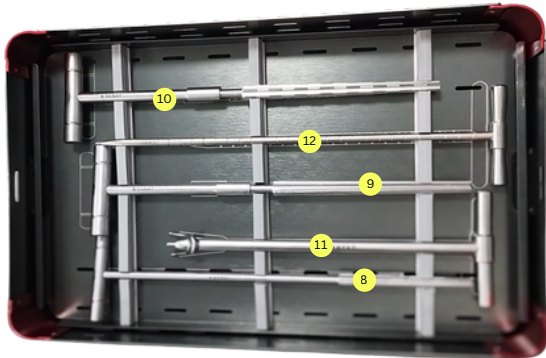

Sr.No	Product Code	Size
1	ISO43-01	Bipolar Rasp
2	ISO43-02	Tomy Bar For Bipolar Rasp
3	ISO43-03	Murphy Bone Skid
4	ISO43-04	Hollow Chisel
5	ISO43-05	Nylon Face Impactor
6	ISO43-06	Extractor Set
7	ISO43-07	Spare Hook For Extractor
8	ISO43-08	Entry Reamer Small Plain
9	ISO43-09	Entry Reamer Large Plain
10	ISO43-10	Entry Reamer Big Serrated
11	ISO43-11	Verson Handle
12	ISO43-12	Restrictor Handle
13	ISO43-13	Head Gauge Set
14	ISO43-14	Judget Head Extractor
15	ISO43-15	Bipolar Impactor Punch
16	ISO43-16	Bipolar Impactor Threaded
17	ISO43-17	Trial Cup 37mm
18	ISO43-18	Trial Cup 39mm
19	ISO43-19	Trial Cup 41mm
20	ISO43-20	Trial Cup 43mm
21	ISO43-21	Trial Cup 45mm
22	ISO43-22	Trial Cup 47mm
23	ISO43-23	Trial Cup 49mm
24	ISO43-24	Trial Cup 51mm
25	ISO43-25	Trial Cup 53mm
26	ISO43-26	Trial Stem
27	ISO43-27	Instrument Box

## AMP Instruments Set

Sr.No	Product Code	Size
1	IS044-01	AMP Rasp
2	IS044-02	Tomy Bar For AMP Rasp
3	IS044-03	Murphy Bone Skid
4	IS044-04	Hollow Chisel
5	IS044-05	Nylon Face Impactor
6	IS044-06	Extractor Set
7	IS044-07	Spare Hook For Extractor
8	IS044-08	Entry Reamer Small Plain
9	IS044-09	Entry Reamer Large Plain
10	IS044-10	Entry Reamer Big Serrated
11	IS044-11	Head Gauge Set
12	IS044-12	Judget Head Extractor
13	IS044-13	Instrument Box

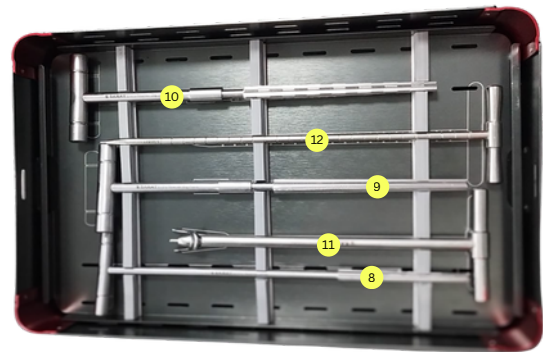
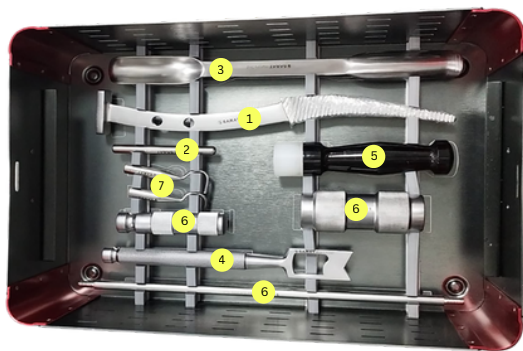

## Modular Bipolar Instrument Set

Sr.No	Product Code	Size
1	ISO45-01	Modular Rasp Small
2	ISO45-02	Modular Rasp Medium
3	ISO45-03	Modular Rasp Large
4	ISO45-04	Tomy Bar For Rasp
5	ISO45-05	Trial Stem Small
6	ISO45-06	Trial Stem Medium
7	ISO45-07	Trial Stem Large
8	ISO45-08	Trial Inner Cup Small
9	ISO45-09	Trial Inner Cup Medium
10	ISO45-10	Trial Inner Cup Large



## Quick Coupling Flexible Reamer Set

Sr.No	Product Code	Size
1	ISO49-01	Flexible Reamer Shaft
2	ISO49-02	Flexible Reamer Shaft for 7.5mm,8.0mm
3	ISO49-03	Reamer Head 7.5mm
4	ISO49-04	Reamer Head 8.0mm
5	ISO49-05	Reamer Head 8.5mm
6	ISO49-06	Reamer Head 9.0mm
7	ISO49-07	Reamer Head 9.5mm
8	ISO49-08	Reamer Head 10.0mm
9	ISO49-09	Reamer Head 10.5mm
10	ISO49-10	Reamer Head 11.0mm
11	ISO49-11	Reamer Head 11.5mm
12	ISO49-12	Reamer Head 12.0mm
13	ISO49-13	Reamer Head 12.5mm
14	ISO49-14	Reamer Head 13.0mm
15	ISO49-15	Instrument Box

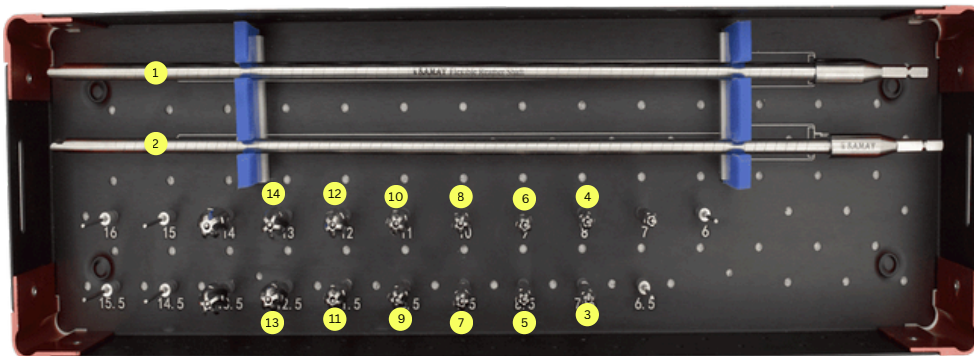

## Flexible Reamer Set

Sr.No	Product Code	Size
1	IS050-01	Flexible Reamer 7.5mm
2	IS050-02	Flexible Reamer 8.0mm
3	IS050-03	Flexible Reamer 8.5mm
4	IS050-04	Flexible Reamer 9.0mm
5	IS050-05	Flexible Reamer 9.5mm
6	IS050-06	Flexible Reamer 10.0mm
7	IS050-07	Flexible Reamer 10.5mm
8	IS050-08	Flexible Reamer 11.0mm
9	IS050-09	Flexible Reamer 11.5mm
10	IS050-10	Flexible Reamer 12.0mm
11	IS050-11	Flexible Reamer 12.5mm
12	IS050-12	Flexible Reamer 13.0mm
13	IS050-13	Instrument Box

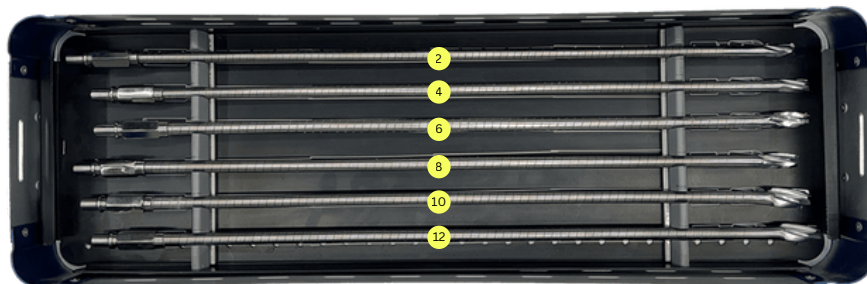
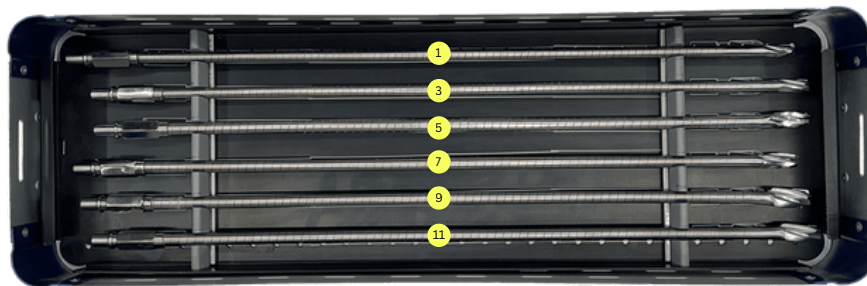

## Spine Instruments Set

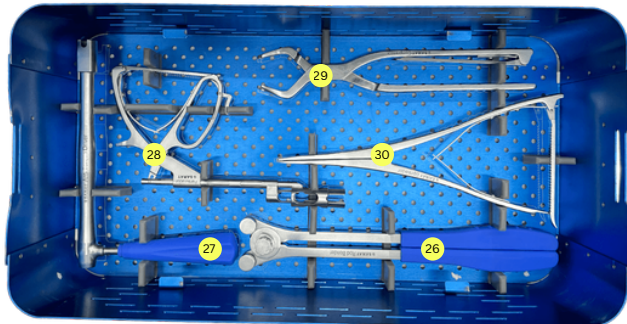
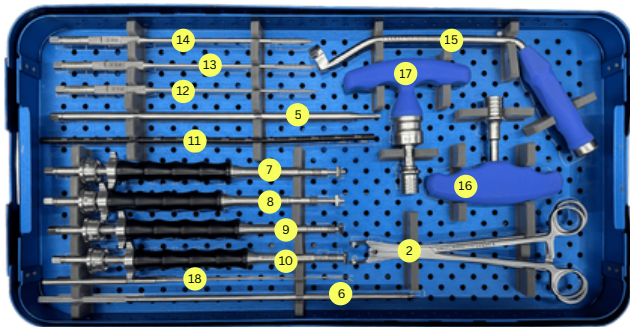
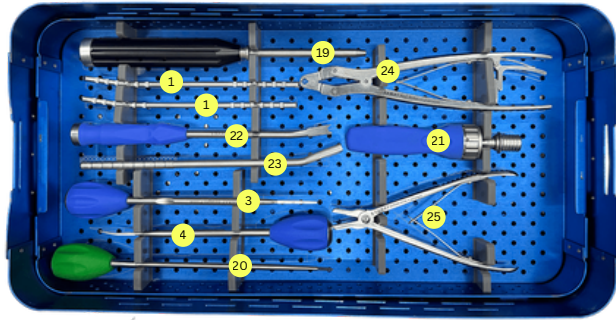

Sr.No	Product Code	Size
1	IS056-01	Rod Rocker
2	IS056-02	Rod Holding Forceps
3	IS056-03	Pedical Probe Straight
4	IS056-04	Pedical Probe Curved
5	IS056-05	Inner Inserter 3.5mm Tip
6	IS056-06	Inner Inserter T25
7	IS056-07	Monoaxial Screw Driver
8	IS056-08	Polyaxial Screw Driver
9	IS056-09	Monoaxial Reduction Screw Driver
10	IS056-10	Polyaxial Reduction Screw Driver
11	IS056-11	Rod Template
12	IS056-12	Bone Tap 4.5mm
13	IS056-13	Bone Tap 5.5mm
14	IS056-14	Bone Tap 6.5mm
15	IS056-15	Reduction Screw Protector
16	IS056-16	Quick Coupling T-Handle
17	IS056-17	Quick Coupling T-Handle Torque Limiter
18	IS056-18	Awl
19	IS056-19	Pedical Marker Inserter Holder
20	IS056-20	Pedical Marker Pin Cylindrical
21	IS056-21	Ratchet Handle
22	IS056-22	Rod Pusher
23	IS056-23	Reduction Screw Bracker
24	IS056-24	Rod Rotator Forceps
25	IS056-25	Breakable Forceps
26	IS056-26	Rod Bender
27	IS056-27	Anti Torque Driver
28	IS056-28	Persuader
29	IS056-29	Compressor Forceps
30	IS056-30	Distractor Forceps
31	IS056-31	Instrument Box

## Spine Hook Instruments Set

Sr.No	Product Code	Size
1	ISO57-01	Thoracic Facet Finder
2	ISO57-02	Pedicle Elevator
3	ISO57-03	Laminar Elevator
4	ISO57-04	Compact Hook Holder
5	ISO57-05	Insertor for Compact Hook Holder
6	ISO57-06	Instrument Box

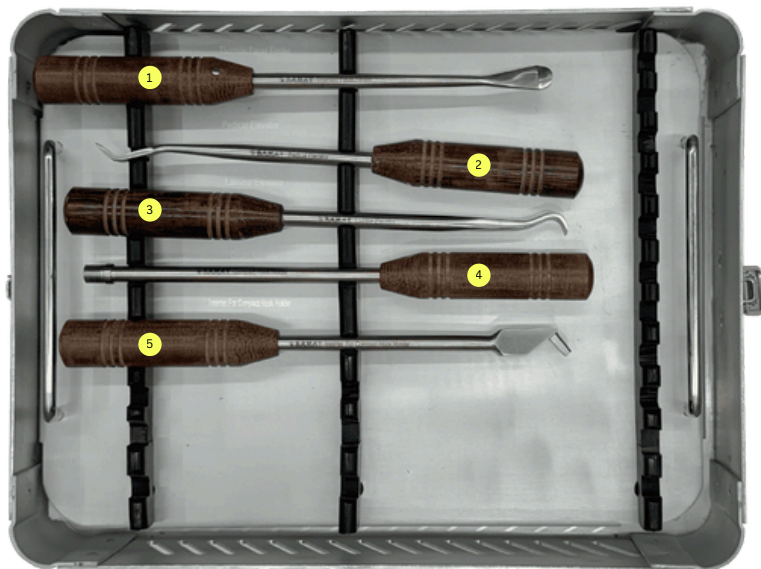

## Posterior Cervical Screw Instruments Set

Sr.No	Product Code	Size
1	IS058-01	Rod Holding Forceps
2	IS058-02	Hook Holding Forceps
3	IS058-03	Depth Gauge
4	IS058-04	Rod Template
5	IS058-05	Inner Tightner 2.5mm Tip
6	IS058-06	Bone Tap 3.5mm Screw
7	IS058-07	Bone Tap 4.0mm Screw
8	IS058-08	Drill Bit 2.4x215mm
9	IS058-09	Drill Bit 2.7x215mm
10	IS058-10	Inner Inserterv 2.5mm Tip
11	IS058-11	Straight Probe
12	IS058-12	Curved Probe
13	IS058-13	Bender (Pair)
14	IS058-14	Quick Coupling T-Handle
15	IS058-15	Posterior Screw Driver
16	IS058-16	Probe
17	IS058-17	Counter Torque
18	IS058-18	Awl
19	IS058-19	Pedical Marker Inserter Holder
20	IS058-20	Pedical Marker Pin Cylindrical
21	IS058-21	Pedical Marker Pin Spheroidal
22	IS058-22	Quick Coupling Handle
23	IS058-23	Rod Pusher
24	IS058-24	Screw Driver Shaft 2.5mm Tip
25	IS058-25	Rod Bender
26	IS058-26	Drill Guide
27	IS058-27	Rod Cutter
28	IS058-28	Distractor Forceps
29	IS058-29	Compressor Forceps
30	IS058-30	Rod Holding Forceps
31	IS058-31	Instrument Box

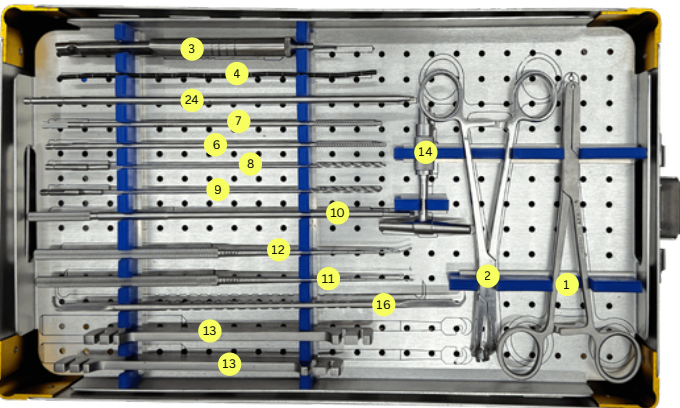
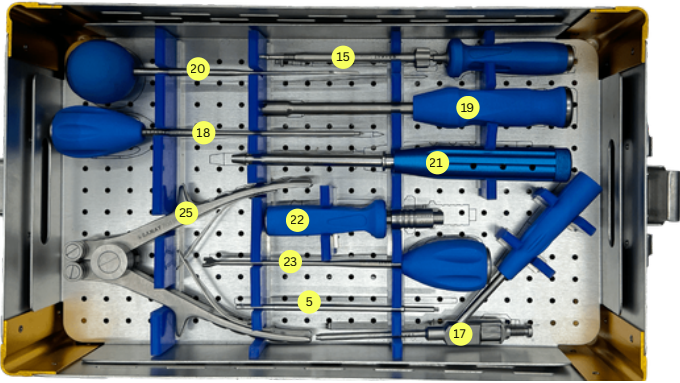
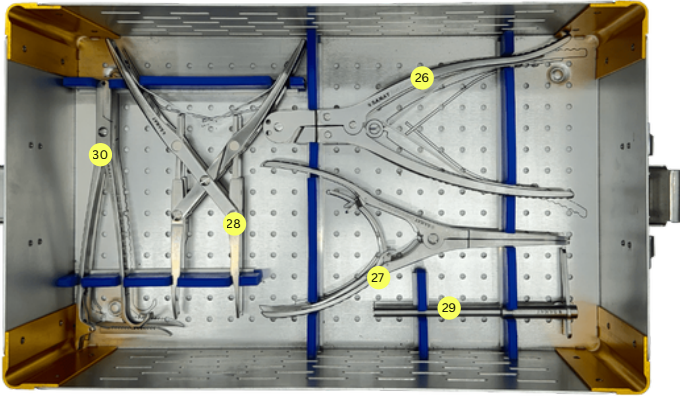

## Anterior Cervical Plate Instrument Set

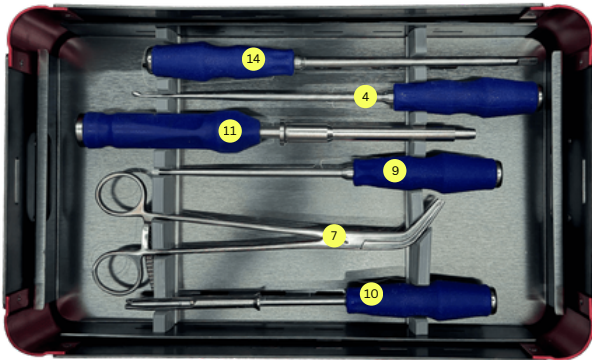
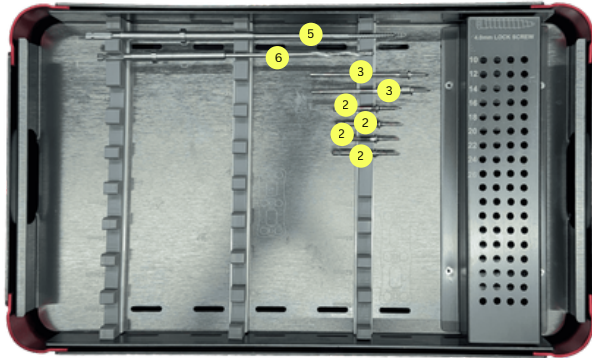
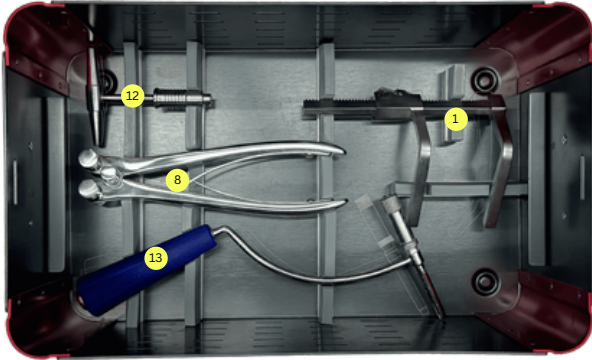

Sr.No	Product Code	Size
1	ISO59-01	Cervical Distractor
2	ISO59-02	Pin for Cervical Distractor
3	ISO59-03	Plate Holding Pin
4	ISO59-04	Bone Curette 3mm
5	ISO59-05	Adjustable Tap 4mm
6	ISO59-06	Adjustable Drill Bit 3mm
7	ISO59-07	Plate Holding Forceps
8	ISO59-08	Plate Bender
9	ISO59-09	Lock Screw Driver For H Shape Plate
10	ISO59-10	Self Holding Screw Driver 2.5mm Tip
11	ISO59-11	Plate Holding Pin Holder
12	ISO59-12	Quick Coupling T-Handle
13	ISO59-13	Drill Guide
14	ISO59-14	Plate Pusher
15	ISO59-15	Instrument Box

## Spine Tilif, Plif and Cage Instruments Set

Sr.No	Product Code	Size
1	IS060-01	Chisel 7mm
2	IS060-02	Chisel 8mm
3	IS060-03	Chisel 9mm
4	IS060-04	Chisel 10mm
5	IS060-05	Plif Cage Trial 7mm
6	IS060-06	Plif Cage Trial 8mm
7	IS060-07	Plif Cage Trial 9mm
8	IS060-08	Plif Cage Trial 10mm
9	IS060-09	Plif Cage Trial 11mm
10	IS060-10	Plif Cage Trial 12mm
11	IS060-11	Bullet Cage Trial 7mm
12	IS060-12	Bullet Cage Trial 8mm
13	IS060-13	Bullet Cage Trial 9mm
14	IS060-14	Bullet Cage Trial 10mm
15	IS060-15	Bullet Cage Trial 11mm
16	IS060-16	Bullet Cage Trial 12mm
17	IS060-17	Kidney & Tlif Cage Trial 7mm
18	IS060-18	Kidney & Tlif Cage Trial 8mm
19	IS060-19	Kidney & Tlif Cage Trial 9mm
20	IS060-20	Kidney & Tlif Cage Trial 10mm
21	IS060-21	Kidney & Tlif Cage Trial 11mm
22	IS060-22	Kidney & Tlif Cage Trial 12mm
23	IS060-23	Quick Coupling T-Handle
24	IS060-24	Bone Graft Holder
25	IS060-25	Bone Graft Punch
26	IS060-26	Cage Pusher Straight
27	IS060-27	Cage Pusher Curved
28	IS060-28	Bone Curette Ring Type Straight
29	IS060-29	Bone Curette Ring Type Curved
30	IS060-30	Bone Curette Square Type Straight
31	IS060-31	Bone Curette Square Type Curved
32	IS060-32	Plif Cage Holder
33	IS060-33	Bullet Cage Holder
34	IS060-34	Kidney & Tlif Cage Holder
35	IS060-35	Instrument Box

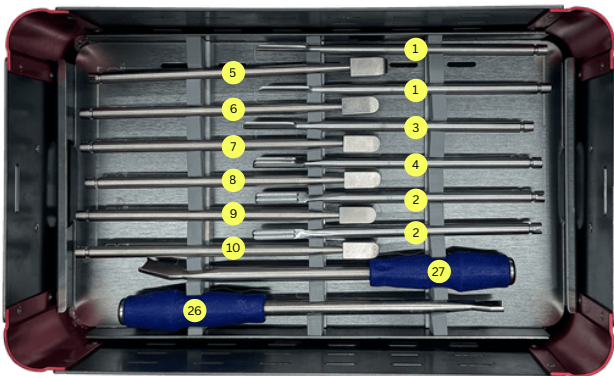
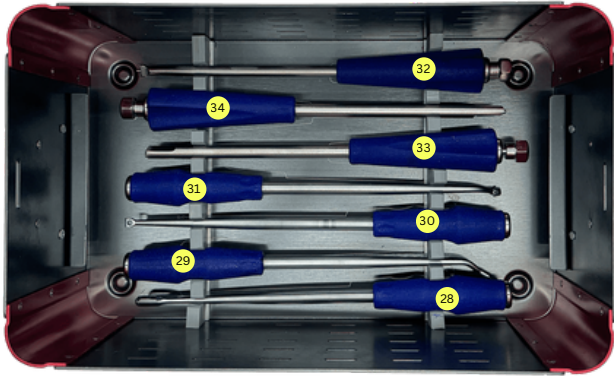

## Mesh, Eco & Expandable Cage Instruments Set

Sr.No	Product Code	Size
1	IS061-01	Cage Holder Piler
2	IS061-02	Cage Pusher Curved
3	IS061-03	Cage Pusher Straight
4	IS061-04	Tomy Bar Straight
5	IS061-05	Tomy Bar Curved
6	IS061-06	Lock Screw Driver

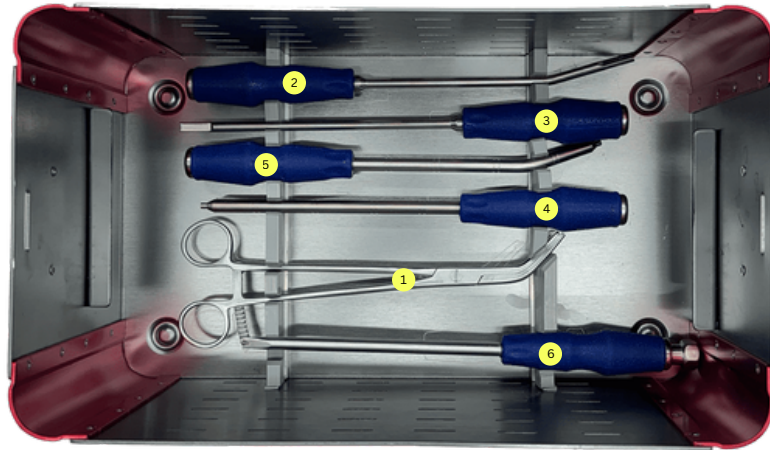

## Cervical Cage Instrument Set

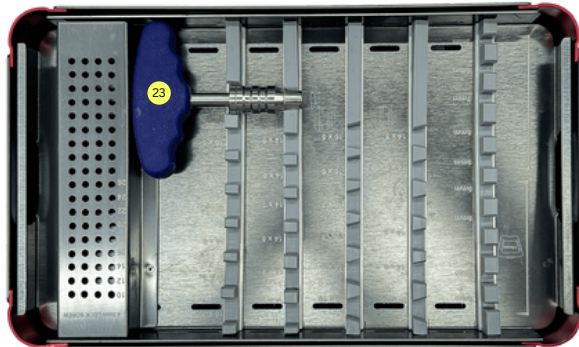
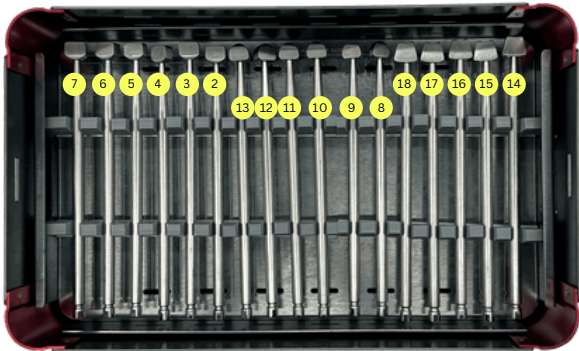
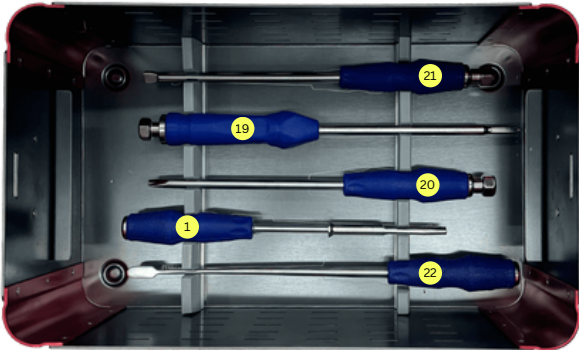

Sr.No	Product Code	Size
1	ISO62-01	Self Holding Screw Driver 2.5mm Tip
2	ISO62-02	Cervical Dio Cage Trial 5mm
3	ISO62-03	Cervical Dio Cage Trial 6mm
4	ISO62-04	Cervical Dio Cage Trial 7mm
5	ISO62-05	Cervical Dio Cage Trial 8mm
6	ISO62-06	Cervical Dio Cage Trial 9mm
7	ISO62-07	Cervical Dio Cage Trial 10mm
8	ISO62-08	Cervical Cage Trial 5mm
9	ISO62-09	Cervical Cage Trial 6mm
10	ISO62-10	Cervical Cage Trial 7mm
11	ISO62-11	Cervical Cage Trial 8mm
12	ISO62-12	Cervical Cage Trial 9mm
13	ISO62-13	Cervical Cage Trial 10mm
14	ISO62-14	Cervical Cage With Screw Trial 5mm
15	ISO62-15	Cervical Cage With Screw Trial 6mm
16	ISO62-16	Cervical Cage With Screw Trial 7mm
17	ISO62-17	Cervical Cage With Screw Trial 8mm
18	ISO62-18	Cervical Cage With Screw Trial 9mm
19	ISO62-19	Cervical Dio & Cervical Cage Holder
20	ISO62-20	Cervical Cage With Screw Cage Holder
21	ISO62-21	Lock Screw Driver For Cervical Cage Screw
22	ISO62-22	Bone Curette Straight
23	ISO62-23	Quick Coupling T-Handle
24	ISO62-24	Instrument Box

## Oscillating Saw

Sr.No	Product Code	Size
1	IS064-01	Handpiece
2	IS064-02	Battery
3	IS064-03	Saw Blades
4	IS064-04	Charger
5	IS064-05	Sterilization Ring
6	IS064-06	Instrument Box

